



GENERAL CATALOGUE 2025



VIDEO INTERCOM AND ACCESS CONTROL





11 **kits** _____
Clip | Soul | Soul/Access | Nexa | Rock

57 **panels** _____
Supra | Sixty5 | Nexa | Artis

93 **indoor units** _____
Edge | Art | T-500

113 **accessories** _____
Door locks, power supplies, cables...

121 **access control** _____

141 **technical information** _____

153 **spare parts** _____

163 **references** _____

| about **US**

The security that only a leader can offer

Golmar is a Spanish company founded in 1954, with presence in most international markets. Recognized as an outstanding market leader in the development of video door entry equipment, and in the offer of integrated electronic security solutions, it has a wide range of products to meet the needs of the residential and tertiary sectors.

+70
years

offering communication and security solutions

55
countries

a continuously expanding global presence, offering solutions tailored to the needs of each market

172
people

Golmar is a company that joins efforts to develop the most advanced systems and to offer an excellent service



1954

Golmar was founded in Barcelona as a family business, being its first product an intercom for offices. Four years later it presents a communication equipment for homes.

1978

The Domino telephone is awarded multiple design prizes. Market launch of the first video door entry system. Opening of branches in the most important cities in Spain.

1994

First Spanish company to develop a digital video door entry system, an unmistakable sign of its high degree of innovation. Three years later, the company moves to a modern 6,500m² building.

2001

Obtained ISO 9000:2000 certification. In 2004, in celebration of its 50th anniversary, it increased its international presence with the creation of two European subsidiaries.

a company in constant growth

2015

Thanks to the application of the latest technologies, Golmar develops 2-wire video door entry systems, which provide video to existing audio installations, and an innovative IP system with countless features.

2017

Incorporation of a domotic system via radio and launch of applications for smartphones that allow the management of the video door entry and access control among other systems.

2025

Golmar is preparing for the introduction of new developments coinciding with its 70th anniversary, at a time when systems integration and connectivity is a growing demand.

GLOBAL

| presence

Our creative and functional solutions, which integrate communication and building security, have enabled the execution of prestigious projects around the world with our seal of guarantee.



EMAAR StandPoint
Downtown Dubai, Dubai



Colombo City Centre
Colombo, Sri Lanka



Urban Treasure
Jalan Eunos, Singapore



The Kube
Tarragona, Spain

KRONOS
HOMES



Príncipe Felipe Pavilion
Zaragoza, Spain



Las Condes 7520
Santiago, Chile



Avantra
Sydney, Australia



Ikon
Valencia, Spain

KRONOS
HOMES



Axel Towers
Copenhagen, Denmark



One Hill
Casablanca, Morocco



Bloom Towers
Jumeirah Village, Dubai



Mall of Dilmunia
Dilmunia Island, Bahrain

Our **VALUES**

One of our main objectives is to identify the needs of each project, offering solutions that best suit the requirements, with special attention to **design, performance and efficiency.**

Solutions and services

We pride ourselves on our exceptional customer service, providing comprehensive support at every stage of the project, from pre-sales consultations to assistance during and after installation.

Our expert and committed team of professionals is always ready to respond to any inquiry, offering quality guidance.



Our Clients

Our customers are our most valuable asset, and their satisfaction is the key to our success. We pay special attention to the needs of the different groups involved in the business, emphasizing the end-user experience.

Our commercial and prescription departments provide support to:

- Architects
- Engineers and consulting firms
- Interior designers
- Developers
- Construction companies
- Installers

Universal designs

Golmar develops products to suit everyone's needs. Accessibility and inclusion, especially for people with vision, hearing and mobility limitations, are prerequisites of our designs and an important part of our values.

The integration of inductive loop amplifiers for the hearing impaired, system status messages in different languages or cameras with extended viewing angles are some of the innovations incorporated in our equipment to welcome everyone.

At Golmar we constantly strive to improve and progress, to achieve excellence. An example of this is our responsibility to care for the environment; we have initiated a process of changing the packaging of all our products, using recyclable cardboard, vegetable-based inks and reducing the use of plastics to a minimum.

Our *leitmotiv*

From now on, each package of our products will convey a clear and universal message: "we take care of you, of your home", to give voice to our commitment to build sustainable homes and a healthy future.

our News

Sixty5 Code

CODED PANEL

A reference for two years in the market of advanced video intercom solutions. Now also available in **AISI316** stainless steel with mirror effect.



Page 71

Sixty5 Touch

TOUCH SCREEN DOOR PANEL

Its **IK10** protection rating makes it one of the most resistant panels in the residential communications sector. Three finishes and fully customisable graphic interface.



Page 67

supra

MODULAR PANEL

The new door panel that exceeds all expectations, with an IP65 watertightness rating that distinguishes it from other panels in the sector. **Wi-Fi programming** and automatic coding of pushbuttons are some of the technological innovations incorporated in this panel.



Page 59

clip

SURFACE MOUNTING PANEL WITH IP TECHNOLOGY

Ideal for villa installations and as a private call panel at the entrance of the house. It incorporates the **SmartPrompt function** that changes the colour of the call button depending on the system status.



Page 15

artis

NARROW DESIGN WITH WIDE FEATURES

With its extremely small dimensions, this aluminium panel is ideal for door profiles in small buildings with up to 5 flats. With all the advantages of G2+ technology with **2-wire installation**.



Page 90

edge

7" TOUCH SCREEN MONITOR

Complete renewal of the iPG+ range, with a new **intuitive and modular user interface** and the possibility of daisy-chain installation. Only 13 mm depth and an ingenious mounting system.



Page 99



COMMITTED TO INNOVATION



kits

VIDEO **12**

Summary table	12
N Clip	14
Soul	18
Soul/Access	22
N Rock	26
Nexa	30

















































































































AUDIO **38**

Summary table	38
Soul	40
Rock	42
Nexa G2+	44
N Nexa 4+N	50

ACCESS CONTROL **54**

Nexa	54
------	----

OUTDOOR PANELS

	KIT REFERENCE	CODE	INSTALLATION	NO. OF APARTMENTS	PAGE	MOUNTING	SECOND DOOR OPENER	ADDITIONAL PANELS (1)	CCTV INPUT	ACCESS CONTROL
 70 x 170 x 27 mm	C5110/EDGE 7/G+	12305110		1	16	SURFACE		+98		 PROXIMITY
	C5110/EDGE 7W/G+	12305113		1	16	SURFACE		+98		 PROXIMITY
	C5110/EDGE 7WB/G+	12305113B		1	17	SURFACE		+98		 PROXIMITY
	C5110/EDGE 7AW/G+	12305114		1	16	SURFACE		+98		 PROXIMITY
 90 x 170 x 27 mm	S5110/ART 4 XLITE	12205115		1	20	SURFACE		+3		
	S5110/ART 4B	12205114B		1	20	SURFACE		+3		 PROXIMITY
	S5110/ART 4W LITE	12205114W		1	20	SURFACE		+3		
	S5110/ART 7 LITE	12205120		1	20	SURFACE		+3		
	S5110/ART 7H	12205116H		1	20	SURFACE		+3		 PROXIMITY
 87 x 188 x 30 mm	S5110 ACCESS/ART 4	12205140		1	24	SURFACE		+3		 PIN
	S5110 ACCESS/ART 4WH	12205145		1	24	SURFACE		+3		 PIN
	S5110 ACCESS/ART 7H	12205170		1	24	SURFACE		+3		 PIN
	S5110 ACCESS/ART 7W	12205175		1	24	SURFACE		+3		 PIN
 144 x 144 mm	R5110/ART 4 XLITE	12205122		1	28	EMBEDDED		+3		
	R5110/ART 4W LITE	12205121		1	28	EMBEDDED		+3		
	R5110/ART 7 LITE	12205127		1	28	EMBEDDED		+3		
	R5110/ART 7W	12205129		1	28	EMBEDDED		+3		
 134 x 150 mm	NX5110/ART 7W	12205119		1	32	EMBEDDED		+3		
	N5110/ART 4 XLITE	12205112		1	33	EMBEDDED		+3		
 128 x 153 mm	N5220/ART 4 XLITE	12205222		2	33	EMBEDDED		+3		
	N5110/ART 4W LITE	12205111		1	33	EMBEDDED		+3		
	N5220/ART 4W LITE	12205221		2	33	EMBEDDED		+3		
	N5110/ART 7 LITE	12205117		1	33	EMBEDDED		+3		
	N5220/ART 7 LITE	12205227		2	33	EMBEDDED		+3		
 128 x 256 mm	N5204/ART 4 XLITE	12415204		4	34	EMBEDDED		+3		
	N5206/ART 4 XLITE	12415206		6	34	EMBEDDED		+3		
	N5208/ART 4 XLITE	12415208		8	34	EMBEDDED		+3		
	N5210/ART 4 XLITE	12415210		10	34	EMBEDDED		+3		
	N5212/ART 4 XLITE	12415212		12	35	EMBEDDED		+3		
 128 x 358 mm	N5214/ART 4 XLITE	12415214		14	35	EMBEDDED		+3		
	N5216/ART 4 XLITE	12415216		16	35	EMBEDDED		+3		
	N5218/ART 4 XLITE	12415218		18	35	EMBEDDED		+3		
	N5221/ART 4 XLITE	12415220		20	36	EMBEDDED		+3		
	N5222/ART 4 XLITE	12415222		22	36	EMBEDDED		+3		

Wi-Fi monitors allow call forwarding to the smartphone via the G2Call+ app

NEW

clip

VIDEO DOOR ENTRY KITS
surface panel







CLIP panel

- Graphite-colour die-cast aluminium housing
- Black acrylic front panel
- 2 MPx CMOS camera with 150° wide-angle lens
- Vandal resistance rating **IK07** and weatherproof **IP65**
- Prompt messages and call button with "SmartPrompt" light indication of different system status
- 13.56MHz RFID proximity reader with Wiegand26 and RS485 outputs
- Bottom head with space for illuminated card holder or laser engraving
- Door opening via QR codes (models with Wi-Fi monitor)
- Relay output for door activation
- Use with 12VDC door lock
- Compatible with PoE 48V switch and connection via RJ-45 connector, with the possibility of local 12Vdc power supply.
- Wall installation with rainshield included
- Dimensions: 70(W) x 170(H) x 27(D) mm.



EDGE monitors

- Black or white ABS plastic housing
- Tempered glass front
- High-resolution 1024 x 600 px IPS touch screen in 16:9 aspect ratio
- Customizable user interface and background image, available in 16 languages
- Hands-free communication with high-efficiency hidden speaker
- Selectable ring tones and programmable do not disturb function with light indication
- Preview of the system's IP panels and cameras
- Selectable opening of up to two doors per panel
- Activation of auxiliary devices, such as staircase light (requires the use of an external relay unit)
- Programmable automatic door opening function on call reception
- Input for doorbell call button and output for auxiliary sounder
- Communication with other units in the same apartment
- Event-log and image capture of missed calls with voicemail function
- Internal memory for recording up to 100 images and video on microSD card (not included), with automatic deletion after 30 days
- 8 alarm inputs and 2 programmable relay outputs (except model A)
- Up to 6 units within the same apartment
- 48V PoE power supply, connection via RJ-45 connector, with the possibility of local power supply at 12Vdc.
- Wall installation by means of RC-EDGE wall mounting bracket (not included) adaptable to universal enclosure
- Dimensions with terminal connector: 179(W) x 116(H) x 21(D) mm
- Optional:
 -  Integrated Wi-Fi module to forward calls to smartphone, by using the G2Call+ app
 -  Compatibility with Alexa and Google Home devices
 -  Cloud image memory
 -  Version with Android™ 12 operating system and two independent network LAN connectors (A models) allowing the installation of applications and control of other devices





C5110/EDGE 7/G+

12305110

1-way kit with image recording

- 12325701 CLIP/G+ 1 push-button door panel with rainshield
- 12310751 EDGE 7/G+ 7" hands-free monitor
- 12390751 RC-EDGE wall mounting bracket for monitor
- 31600238 SW-104 4-port PoE switch



C5110/EDGE 7W/G+

12305113

1-way kit with Wi-Fi and image recording

- 12325701 CLIP/G+ 1 push-button door panel with rainshield
- 12310753 EDGE 7W/G+ 7" hands-free monitor
- 12390751 RC-EDGE wall mounting bracket for monitor
- 31600238 SW-104 4-port PoE switch



C5110/EDGE 7AW/G+

12305114

1-way kit with Wi-Fi and image recording

- 12325701 CLIP/G+ 1 push-button door panel with rainshield
- 12310754 EDGE 7AW/G+ 7" hands-free monitor
- 12390751 RC-EDGE wall mounting bracket for monitor
- 31600238 4-port PoE switch SW-104





C5110/EDGE 7WB/G+

12305113B

1-way kit with Wi-Fi and image recording

- 12325701 CLIP/G+ 1 push-button door panel with rainshield
- 12310753B EDGE 7WB/G+ 7" hands-free monitor
- 12390751B RC-EDGE/B wall mounting bracket for monitor
- 31600238 4-port PoE switch SW-104



CLIP/G+

12325701

1 push-button door panel with rainshield

CLIP PANEL ACCESSORIES



NFC/US
11812100
User card



TAGNFC/US
11812125
User fob



Soul

VIDEO DOOR ENTRY KITS
surface panel



NEW

Compatible with



Alexa



Google Home

*Only in kits marked with 

SOUL panel

Zamak alloy front, in graphite or black colour

2 MPx CMOS camera with 120° wide-angle lens

Vandal resistance rating **IK07** and weatherproof **IP44**

White LEDs of variable intensity depending on outdoor illumination

LEDs indicators of the different system status

Metallic call button

Input for analog CCTV camera connection

Relay outputs for activation of two doors

Use with 12VDC door lock

Illuminated card holder with RFID proximity reader for up to 60 users (models )

Wall installation with rainshield included

Dimensions: 90(W) x 170(H) x 27(D) mm.



ART monitors

White or black ABS plastic housing

Acrylic front panel with 4.3" or 7" widescreen display

Illuminated capacitive push-buttons, with acoustic push confirmation

Touch screen on ART 7W/G2+ model

Hands-free communication

Selectable ring tones and do not disturb function with light indication

Preview of system panels

Selectable opening of up to two doors per panel

Activation of auxiliary devices, such as staircase light (requires the use of an external relay unit)

Automatic door opening function on call reception

Input for doorbell call button and output for auxiliary sounder

Intercommunication with other indoor units in the same apartment





Wall installation by means of wall mounting bracket (included) adaptable to universal box

Dimensions with terminal connector:

ART 4: 110(W) x 155(H) x 23(D) mm.

ART 7: 220(W) x 155(H) x 23(D) mm.

Optional:

-  Integrated Wi-Fi module for call forwarding to cell phones via free G2Call+ app
-  Compatibility with Alexa and Google Home devices
-  Internal memory for recording up to 100 images and video on microSD card (not included)
-  Cloud image memory
-  Inductive loop amplifier for hearing aids



ART 4



ART 7



S5110/ART 4 XLITE

12205115

1-way kit

- 12225405 SOUL/1 LITE 1 push-button door panel with rainshield
- 12210436 4.3" ART 4 XLITE/G2+ hands-free monitor
- 12240141 FA-G2+/LITE power supply



S5110/ART 4B

12205114B

1-way kit

- 12225401B SOUL/1B 1 push-button door panel with rainshield
- 12210435B 4.3" hands-free monitor ART 4B LITE/G2+
- 12240141 FA-G2+/LITE power supply



S5110/ART 4W LITE

12205114W

1-way kit with Wi-Fi and image recording

- 12225405 SOUL/1 LITE 1 push-button door panel with rainshield
- 12210445 4.3" ART 4W LITE/G2+ hands-free monitor
- 12240141 FA-G2+/LITE power supply



S5110/ART 7 LITE

12205120

1-way kit

- 12225405 SOUL/1 LITE 1 push-button door panel with rainshield
- 12210705 ART 7 LITE/G2+ 7" hands-free monitor
- 12240141 FA-G2+/LITE power supply



S5110/ART 7H

12205116H

1-way kit with image recording

- 12225401 SOUL/1 1 push-button door panel with rainshield
- 12210702 ART 7H/G2+ 7" hands-free monitor
- 12240452 TAGSET/PROG with 2 programming fobs and 5 user fobs
- 2 CARDSET user cards
- 12240100 FA-G2+ power supply



S5110/ART 7W

12205118

1-way kit with Wi-Fi and image recording

- 12225401 SOUL/1 1 push-button door panel with rainshield
- 12210710 ART 7W/G2+ 7" hands-free monitor
- 12240452 TAGSET/PROG with 2 programming fobs and 5 user fobs
- 2 CARDSET user cards
- 12240100 FA-G2+ power supply



RFID proximity reader

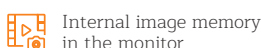

Internal image memory in the monitor



Wi-Fi



Inductive loop amplifier



Black colour



Cloud image memory



Alexa and Google Home



SOUL/1 12225401

1 push-button door panel

12225401	SOUL/1 1 push-button door panel with rainshield
12240452	TAGSET/PROG with 2 programming fobs and 5 user fobs
-	2 CARDSET user cards



SOUL/1B 12225401B

1 push-button door panel with rainshield



SOUL/2 12225402

2 push-buttons panel

12225402	SOUL/2 2 push-buttons panel with rainshield
12240452	TAGSET/PROG with 2 programming fobs and 5 user fobs
-	2 CARDSET user cards



SOUL/4 12225404

4-ways panel

12225404	SOUL/4 4 push-buttons panel with rainshield
12240452	TAGSET/PROG with 2 programming fobs and 5 user fobs
-	2 CARDSET user cards

SOUL PANEL ACCESSORIES



MAC-SOUL
12285611
Replacement frame
160(W) x 260(H) mm



MAC-SOUL/BLACK
12285611B
Black replacement frame
160(W) x 260(H) mm



TAGSET/PROG
12240452
5 user fobs and
2 programming fobs



TAGSET/5
12240450
5 user fobs



CARDSET/5
12240460
5 user cards

Soul ACCESS

VIDEO DOOR ENTRY KITS
surface panel



NEW

**Remote
PIN CHANGE**

S5110 ACCESS/ART 7W kit only

SOUL ACCESS panel

- Zamak alloy front panel in graphite colour
- 2 MPx CMOS camera with 150° wide-angle lens
- Vandal resistance rating **IK07** and weathering **IP54**
- White LEDs of variable intensity depending on outdoor illumination
- LEDs indicators of the different system status
- Call up to 128 apartments via illuminated keypad
- PIN access control of 40 codes
- Access PIN change from G2Call+ application remotely in the S5110 ACCESS/ART 7W kit
- Input for analog CCTV camera connection
- Relay outputs for activation of two doors
- Use with 12VDC door lock
- Wall installation with rainshield included
- Dimensions: 87(W) x 188(H) x 30(D) mm.



ART monitors

- Housing made of white ABS plastic
- Acrylic front panel with 4.3" or 7" widescreen display
- Illuminated capacitive push-buttons, with acoustic push confirmation
- Touch screen on ART 7W/G2+ model
- Hands-free communication
- Selectable ring tones and do not disturb function with light indication
- Preview of system panels
- Selectable opening of up to two doors per panel
- Activation of auxiliary devices, such as staircase light (requires the use of an external relay unit)
- Automatic door opening function on call reception
- Input for doorbell call button and output for auxiliary sounder

Intercommunication with other indoor units in the same apartment





Wall installation by means of terminal connector (included) adaptable to universal box

Dimensions with terminal connector:

ART 4: 110(W) x 155(H) x 23(D) mm.

ART 7: 220(W) x 155(H) x 23(D) mm.

Optional:

-  Integrated Wi-Fi module for call forwarding to cell phones via free G2Call+ app
-  Compatibility with Alexa and Google Home devices
-  Internal memory for recording up to 100 images and video on microSD card (not included)
-  Cloud image memory
-  Inductive loop amplifier for hearing aids



ART 4

ART 7



S5110 ACCESS/ART 4

12205140

1-way kit with image recording

- 12225403 SOUL/ACCESS coded panel with rainshield
- 12210430 ART 4/G2+ 4.3" hands-free monitor
- 12240141 FA-G2+/LITE power supply



S5110 ACCESS/ART 4WH

12205145

1-way kit with Wi-Fi and image recording

- 12225403 SOUL/ACCESS coded panel with rainshield
- 12210437 ART 4WH/G2+ 4.3" hands-free monitor
- 12240141 FA-G2+/LITE power supply



S5110 ACCESS/ART 7H

12205170

1-way kit with image recording

- 12225403 SOUL/ACCESS coded panel with rainshield
- 12210702 7" Hands-free Monitor ART 7H/G2+
- 12240100 FA-G2+ power supply



S5110 ACCESS/ART 7W

12205175

1-way kit with Wi-Fi and image recording

- 12225403 SOUL/ACCESS coded panel with rainshield
- 12210710 7" ART 7W/G2+ hands-free monitor
- 12240100 FA-G2+ power supply



ACCESS



SOUL/ACCESS

12225403

Coded panel with rainshield

SOUL ACCESS ACCESSORIES



RC-SOUL/ACCESS

12225433

Mounting bracket for mounting without rainshield



MAC-SOUL/ACCESS

12285612

Replacement frame 160(W) x 260(H) mm

NEW

Rock

VIDEO DOOR ENTRY KITS
vandal-resistant flush
mounting panel



ROCK panel

- Curved front in graphite-colour die-cast aluminium
- Vandal resistance index **IK09** and weathering **IP44**
- 2 MPx pan & tilt CMOS camera and 120° wide-angle lense
- White LEDs of variable intensity depending on outdoor illumination
- Double-wall sound grille to prevent access by sharp objects
- Stainless steel call button
- On-board acoustic signaling of call in progress
- Input for analog CCTV camera connection
- Relay outputs for activation of two doors
- Use with 12VDC door lock
- Dimensions:

Exterior: 144(W) x 144(H) mm.

Embedded: 131(W) x 131(H) x 45(D) mm.



ART monitors

- Housing made of white ABS plastic
- Acrylic front panel with 4.3" or 7" widescreen display
- Illuminated capacitive push-buttons, with acoustic push confirmation
- Touch screen on ART 7W/G2+ model
- Hands-free communication
- Selectable ring tones and do not disturb function with light indication
- Preview of system panels
- Selectable opening of up to two doors per panel
- Activation of auxiliary devices, such as staircase light (requires the use of an external relay unit)
- Automatic door opening function on call reception
- Input for doorbell call button and output for auxiliary sounder

Intercommunication with other indoor units in the same apartment





Wall installation by means of wall mounting bracket (included) adaptable to universal box

Dimensions with terminal connector:

ART 4: 110(W) x 155(H) x 23(D) mm.

ART 7: 220(W) x 155(H) x 23(D) mm.

Optional:

-  Integrated Wi-Fi module for call forwarding to cell phones via free G2Call+ app
-  Compatibility with Alexa and Google Home devices
-  Internal memory for recording up to 100 images and video on microSD card (not included)
-  Cloud image memory



ART 4



ART 7



R5110/ART 4 XLITE

12205122

1-way kit

- 12225295 PVS-295/G2+ GRF 1 push-button door panel
- 11290290 Embedding box M
- 12210436 4.3" ART 4 XLITE/G2+ hands-free monitor
- 12240141 FA-G2+/LITE power supply



R5110/ART 7 LITE

12205127

1-way kit

- 12225295 PVS-295/G2+ GRF 1 push-button door panel
- 11290290 Embedding box M
- 12210705 7" ART 7 LITE/G2+ hands-free monitor
- 12240141 FA-G2+/LITE power supply



R5110/ART 4W LITE

12205121

1-way kit with Wi-Fi and image recording

- 12225295 PVS-295/G2+ GRF 1 push-button door panel
- 11290290 Embedding box M
- 12210445 4.3" ART 4W LITE/G2+ hands-free monitor
- 12240141 FA-G2+/LITE power supply



R5110/ART 7W

12205129

1-way kit with Wi-Fi and image recording

- 12225295 PVS-295/G2+ GRF 1 push-button door panel
- 11290290 Embedding box M
- 12210710 7" ART 7W/G2+ hands-free monitor
- 12240100 FA-G2+ power supply

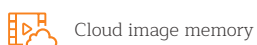
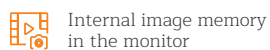



PVS-295/G2+ GRF

12225295

1 push-button door panel

ACCESSORIES ROCK PANEL



VIS-295/GRF

11290499A

Visor

152(W) x 144(H) mm



MP/GRF

11229509A

Surface box

144(W) x 144(H) x 45(D) mm



MP-VIS/GRF

11290496A

Surface box with rainshield

157(W) x 153(H) x 36(D) mm



MAC-295/P

11295611

Replacement frame
200(W) x 200(H) mm



MAC-295/G

11295615

Replacement frame
200(W) x 300(H) mm



Nexa

VIDEO DOOR ENTRY KITS

flush mounting panels



NEXA ALUMINIUM and NEXA STAINLESS STEEL panels

Front in anodised aluminium or stainless steel AISI 316
2 MPx pan & tilt CMOS camera and 120° wide-angle lens

White LEDs of variable intensity depending on outdoor illumination

Illuminated indicators and prompt messages of the different system status

Illuminated card holders and stainless steel covered call buttons

Input for analog CCTV camera connection

Relay outputs for activation of two doors

Use with 12VDC door lock

Dimensions:

Nexa Inox

1-way kit (1 height module)

Exterior: 134(W) x 150(H) mm.

Embedded: 125(W) x 140(H) x 56(D) mm.

Nexa Aluminium

1 and 2 apartment kits (1 module height)

Exterior: 128(W) x 153(H) mm.

Embedded: 99(W) x 133(H) x 56(D) mm.

Kits from 3 to 12 apartments (2 modules high)

Exterior: 128(W) x 256(H) mm.

Embedded: 99(W) x 238(H) x 56(D) mm.

Kits from 14 to 22 apartments (3 modules high)

Exterior: 128(W) x 358(H) mm.

Embedded: 99(W) x 328(H) x 56(D) mm.

**ART monitors**

Housing made of white ABS plastic

Acrylic front panel with 4.3" or 7" widescreen display

Illuminated capacitive push-buttons, with acoustic push confirmation

Touch screen on ART 7W/G2+ model

Hands-free communication

Selectable ring tones and do not disturb function with light indication

Preview of system panels

Selectable opening of up to two doors per panel

Activation of auxiliary devices, such as staircase light (requires the use of an external relay unit)

Automatic door opening function on call reception

Input for doorbell call button and output for auxiliary sounder

Intercommunication with other indoor units of the same apartment, the building and the concierge

Wall installation by means of wall mounting bracket (included) adaptable to universal box

Dimensions with terminal connector:

ART 4: 110(W) x 155(H) x 23(D) mm.

ART 7: 220(W) x 155(H) x 23(D) mm.

Optional:

 Integrated Wi-Fi module for call forwarding to cell phones via free G2Call+ app

 Compatibility with Alexa and Google Home devices

 Internal memory for recording up to 100 images and video on microSD card (not included)

 Cloud image memory



ART 4

ART 7



NX5110/ART 7W

12205119

1-way kit with Wi-Fi and image recording

- Nexa Inox 1 push-button panel
- 11280610 CE610 embedding box
- 12210710 ART 7W/G2+ 7" hands-free monitor
- 12240100 FA-G2+ power supply

— G2CALL+

Mobile phone app to connect with your home

Answer calls at your front door, view images from the outdoor panel or surveillance cameras, and even open the door to have a delivery left for you in your absence. **Share all these functions with others easily.**

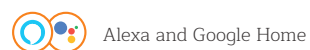
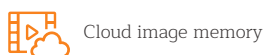
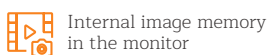

**N5110/ART 4 XLITE**

12205112

1-way kit

Nexa Aluminium 1 push-button panel

11880902A NCEV-90CS embedding box

12210436 ART 4 XLITE/G2+ 4.3" hands-free monitor

12240141 FA-G2+/LITE power supply

**N5220/ART 4 XLITE**

12205222

Kit for 2 apartments

Nexa Aluminium 2 push-buttons panel

11880902A NCEV-90CS embedding box

12210436 2x ART 4 XLITE/G2+ 4.3" hands-free monitors

12240141 FA-G2+/LITE power supply

**N5110/ART 4W LITE**

12205111

1-way kit with Wi-Fi and image recording

Nexa Aluminium 1 push-button panel

11880902A NCEV-90CS embedding box

12210445 ART 4W LITE/G2+ 4.3" hands-free monitor

12240141 FA-G2+/LITE power supply

**N5220/ART 4W LITE**

12205221

Kit for 2 apartments with Wi-Fi and image recording

Nexa Aluminium 2 push-buttons panel

11880902A NCEV-90CS embedding box

12210445 2x ART 4W LITE/G2+ 4.3" hands-free monitors

12240141 FA-G2+/LITE power supply

**N5110/ART 7 LITE**

12205117

1-way kit

Nexa Aluminium 1 push-button panel

11880902A NCEV-90CS embedding box

12210705 7" ART 7 LITE/G2+ hands-free monitor

12240100 FA-G2+ power supply

**N5220/ART 7 LITE**

12205227

Kit for 2 apartments

Nexa Aluminium 2 push-buttons panel

11880902A NCEV-90CS embedding box

12210705 2x ART 7 LITE/G2+ 7" hands-free monitors

12240100 FA-G2+ power supply

N5204/ART 4 XLITE

12415204

Kit for 4 apartments

- Nexa Aluminium 4 push-button panel
- 11880900 NCEV-90C embedding box
- 12210436 4x ART 4 XLITE/G2+ 4.3" hands-free monitors
- 12240100 FA-G2+ power supply
- 12258940A D4L-G2+ video distributor



N5206/ART 4 XLITE

12415206

Kit for 6 apartments

- Nexa Aluminium panel with 6 push-buttons
- 11880900 NCEV-90C embedding box
- 12210436 6x ART 4 XLITE/G2+ 4.3" hands-free monitors
- 12240100 FA-G2+ power supply
- 12258940A 2x D4L-G2+ video distributors



N5208/ART 4 XLITE

12415208

Kit for 8 apartments

- Nexa Aluminium panel with 8 push-buttons
- 11880900 NCEV-90C embedding box
- 12210436 8x ART 4 XLITE/G2+ 4.3" hands-free monitors
- 12240100 FA-G2+ power supply
- 12258940A 2x D4L-G2+ video distributors



N5210/ART 4 XLITE

12415210

Kit for 10 apartments

- Nexa Aluminium panel with 10 push-buttons
- 11880900 NCEV-90C embedding box
- 12210436 10x ART 4 XLITE/G2+ 4.3" hands-free monitors
- 12240100 FA-G2+ power supply
- 12258940A 3x D4L-G2+ video distributors



N5212/ART 4 XLITE

12415212

Kit for 12 apartments

- Nexa Aluminium 12 push-buttons panel
- 11880900 NCEV-90C embedding box
- 12210436 12x ART 4 XLITE/G2+ 4.3" hands-free monitors
- 12240100 FA-G2+ power supply
- 12258940A 3x D4L-G2+ video distributors



x12

N5214/ART 4 XLITE

12415214

Kit for 14 apartments

- Nexa Aluminium 14 push-buttons panel
- 11259906 CEV-90 Embedding box
- 12210436 14x ART 4 XLITE/G2+ 4.3" hands-free monitors
- 12240100 FA-G2+ power supply
- 12258940A 4x D4L-G2+ video distributors



x14

N5216/ART 4 XLITE

12415216

Kit for 16 apartments

- Nexa Aluminium 16 push-button panel
- 11259906 CEV-90 Embedding box
- 12210436 16x ART 4 XLITE/G2+ 4.3" hands-free monitors
- 12240100 FA-G2+ power supply
- 12258940A 4x D4L-G2+ video distributors



x16

N5218/ART 4 XLITE

12415218

Kit for 18 apartments

- Nexa Aluminium panel with 18 push-buttons
- 11259906 CEV-90 Embedding box
- 12210436 18x ART 4 XLITE/G2+ 4.3" hands-free monitors
- 12240100 FA-G2+ power supply
- 12258940A 5x D4L-G2+ video distributors



x18

N5221/ART 4 XLITE

12415220

Kit for 20 apartments

- Nexa Aluminium panel with 20 push-buttons
- 11259906 CEV-90 Embedding box
- 12210436 20x ART 4 XLITE/G2+ 4.3" hands-free monitors
- 12240100 FA-G2+ power supply
- 12258940A 5x D4L-G2+ video distributors



x20

N5222/ART 4 XLITE

12415222

Kit for 22 apartments

- Nexa Aluminium panel with 22 push-buttons
- 11259906 CEV-90 Embedding box
- 12210436 22x ART 4 XLITE/G2+ 4.3" hands-free monitors
- 12240100 FA-G2+ power supply
- 12258940A 6x D4L-G2+ video distributors



x22

ACCESSORIES NEXA PANEL

RAINSHIELDS



INOX

NX711

11881711C

1 height

138(W) x 152(H) mm

ALUMINIUM

N711/AL

11880711

1 height

134(W) x 156(H) mm

N721/AL

11880721

2 heights

134(W) x 259(H) mm

N731/AL

11880731

3 heights

134(W) x 361(H) mm

SURFACE BOXES



ALUMINIUM

N811/AL

11880811

1 height

134(W) x 156(H) x 43(D) mm

N821/AL

11880821

2 heights

134(W) x 259(H) x 43(D) mm

N831/AL

11880831

3 heights

134(W) x 361(H) x 43(D) mm



Assembled and configured panel

SURFACE BOXES WITH INTEGRATED RANISHIELD

	INOX	NX871	11881871C	1 height	138(W) x 154(H) x 58(D) mm
		N871/AL	11880871	1 height	134(W) x 156(H) x 58(D) mm
	ALUMINIUM	N872/AL	11880872	2 heights	134(W) x 259(H) x 58(D) mm
		N873/AL	11880873	3 heights	134(W) x 361(H) x 58(D) mm

45° SURFACE BOXES







	INOX	NX911	11881911	1 height	150(W) x 156(H) x 66(D) mm
		N911/AL	11280912	1 height	128(W) x 152(H) x 140(D) mm
	ALUMINIUM	N921/AL	11280913	2 heights	128(W) x 254(H) x 140(D) mm
		N931/AL	11280914	3 heights	128(W) x 357(H) x 140(D) mm

REPLACEMENT FRAMES

	INOX	NX611/ROCK	11792077	1 height	145(W) x 161(H) mm
		N611/AL	11880620	1 height	200(W) x 278(H) mm
	ALUMINIUM	N611/AL-C	11880624	1 height	150(W) x 230(H) mm
		N621/AL	11880621	2 heights	200(W) x 430(H) mm
		N621/AL-C	11880623	2 heights	150(W) x 330(H) mm
		N631/AL	11890631	3 heights	200(W) x 512(H) mm
		N631/AL-C	11890633	3 heights	150(W) x 430(H) mm



OUTDOOR PANELS

	KIT REFERENCE	CODE	INSTALLATION	NO. OF APARTMENTS	PAGE	MOUNTING	SECOND DOOR OPENER	ADDITIONAL PANELS (1)
 90 x 170 x 27 mm	S4110/T-ART	12204110	G2+	1	41	SURFACE	●	+1
	S4110/ART 1	12204115	G2+	1	41	SURFACE	●	+1
 144 x 144 mm	K-201 GRF	11242014B	4+N	1	43	EMBEDDED		
	K-202 GRF	11242024B	4+N	2	43	EMBEDDED		
	K6-201 GRF	11242016B	4+N	6 x 1	43	EMBEDDED		
 128 x 153 mm	N4101/T-ART	12404101	G2+	1	46	EMBEDDED	●	+3
	N4202/T-ART	12404202	G2+	2	46	EMBEDDED	●	+3
 128 x 256 mm	N4204/T-ART	12404204	G2+	4	46	EMBEDDED	●	+3
	N4206/T-ART	12404206	G2+	6	46	EMBEDDED	●	+3
	N4208/T-ART	12404208	G2+	8	47	EMBEDDED	●	+3
	N4210/T-ART	12404210	G2+	10	47	EMBEDDED	●	+3
	N4212/T-ART	12404212	G2+	12	47	EMBEDDED	●	+3
	N4214/T-ART	12404214	G2+	14	47	EMBEDDED	●	+3
 128 x 358 mm	N4216/T-ART	12404216	G2+	16	48	EMBEDDED	●	+3
	N4218/T-ART	12404218	G2+	18	48	EMBEDDED	●	+3
	N4220/T-ART	12404220	G2+	20	48	EMBEDDED	●	+3
	N4222/T-ART	12404222	G2+	22	48	EMBEDDED	●	+3
	N4110/T-500	11854110	4+N	1	51	EMBEDDED		
 128 x 153 mm	N4220/T-500	11854220	4+N	2	51	EMBEDDED		
	N4130/T-500	11854130	4+N	3	52	EMBEDDED		
 128 x 256 mm	N4140/T-500	11854140	4+N	4	52	EMBEDDED		
	N4150/T-500	11854150	4+N	5	52	EMBEDDED		
	N4160/T-500	11854160	4+N	6	52	EMBEDDED		
	N4280/T-500	11854280	4+N	8	52	EMBEDDED		
	N4210/T-500	11854210	4+N	10	52	EMBEDDED		
	N4212/T-500	11854212	4+N	12	53	EMBEDDED		

INDOOR UNITS

CONVERSATION	VOLUME REGULATOR	ADDITIONAL PHONES (2)	ACTIVATION OF DEVICES	CONNECTION TO CALL REPEATER	"DO NOT DISTURB" FUNCTION	AUTOMATIC OPENING	DIMENSIONS WITH TERMINAL CONNECTOR (W x H x D)
HEADPHONE	●	+3	SAR-G2+	SAV-12	●	●	86 x 154 x 38 mm
HANDS-FREE	●	+3	SAR-G2+	SAV-12	●	●	90 x 138 x 23 mm
HANDSET		+2		S-8			86 x 220 x 56 mm
HANDSET		+2		S-8			86 x 220 x 56 mm
HANDSET		+2		S-8			86 x 220 x 56 mm
HANDSET	●	+3	SAR-G2+	SAV-12	●		86 x 154 x 38 mm
HANDSET	●	+3	SAR-G2+	SAV-12	●		86 x 154 x 38 mm
HANDSET	●	+3	SAR-G2+	SAV-12	●		86 x 154 x 38 mm
HANDSET	●	+3	SAR-G2+	SAV-12	●		86 x 154 x 38 mm
HANDSET	●	+3	SAR-G2+	SAV-12	●		86 x 154 x 38 mm
HANDSET	●	+3	SAR-G2+	SAV-12	●		86 x 154 x 38 mm
HANDSET	●	+3	SAR-G2+	SAV-12	●		86 x 154 x 38 mm
HANDSET	●	+3	SAR-G2+	SAV-12	●		86 x 154 x 38 mm
HANDSET	●	+3	SAR-G2+	SAV-12	●		86 x 154 x 38 mm
HANDSET	●	+3	SAR-G2+	SAV-12	●		86 x 154 x 38 mm
HANDSET	●	+3	SAR-G2+	SAV-12	●		86 x 154 x 38 mm
HANDSET		+2		S-8			86 x 220 x 56 mm
HANDSET		+2		S-8			86 x 220 x 56 mm
HANDSET		+2		S-8			86 x 220 x 56 mm
HANDSET		+2		S-8			86 x 220 x 56 mm
HANDSET		+2		S-8			86 x 220 x 56 mm
HANDSET		+2		S-8			86 x 220 x 56 mm
HANDSET		+2		S-8			86 x 220 x 56 mm
HANDSET		+2		S-8			86 x 220 x 56 mm
HANDSET		+2		S-8			86 x 220 x 56 mm
HANDSET		+2		S-8			86 x 220 x 56 mm

(1) May require additional accessories. Consult
(2) No additional power supply. Consult



Soul

AUDIO DOOR ENTRY KITS
surface panel



SOUL panel

Zamak alloy front panel in graphite colour

Vandal resistance rating **IK07** and weatherproof **IP44**

Metallic call button

Relay outputs for activation of two doors

Use with 12VDC door lock

Wall installation with rainshield included

Dimensions: 90(W) x 170(H) x 27(D) mm.

**T-ART LITE****ART 1****T-ART LITE** telephone and **ART 1** hands-free unit

Housing made of polished ABS plastic in white colour

Capacitive push-buttons with acoustic push confirmation

Selectable ring tones and do not disturb function with light indication

Output for auxiliary call repeater

Input for doorbell call button and activation of auxiliary devices (ART 1 model)

Dimensions with terminal connector:

T-ART: 86(W) x 154(H) x 31(D) mm.

ART 1: 90(W) x 138(H) x 23(D) mm.

**S4110/T-ART**

12204110

1-way kit

12234401 SOUL/1A 1 push-button panel with rainshield

12210101 T-ART LITE/G2+ telephone

12240141 FA-G2+/LITE power supply

**S4110/ART 1**

12204115

1-way kit

12234401 SOUL/1A 1 push-button panel with rainshield

12210140 ART 1/G2+ hands-free audio unit

12240141 FA-G2+/LITE power supply

**SOUL/1A**

12234401

1 push-button door panel with rainshield

SOUL/2A

12234402

2 push-button door panel with rainshield

SOUL/4A

12234404

4 push-button door panel with rainshield

**MAC-SOUL**

12285611

Replacement frame
160(W) x 260(H) mm

Rock

AUDIO DOOR ENTRY KITS

vandal-resistant flush
mounting panel



ROCK panel

Curved front in graphite-colour die-cast aluminium

Vandal resistance index **IK09** and weathering **IP44**

4 mm thick polycarbonate information card holder

Double-wall sound grille to prevent access by sharp objects

Stainless steel call buttons

Electronic call with acoustic signaling on call in progress panel

To be used with 12VAC door opener.

Dimensions:

Outside: 144(W) x 144(H) mm.

Embedded: 131(W) x 131(H) x 45(D) mm.

TEKNA T-500 telephone

Housing made of polished ABS plastic in white colour

Removable handset telephone cord with connectors

Electronic call

Mechanical push-button for door opening

Dimensions: 86(W) x 220(H) x 56(D) mm.



ACCESSORIES ROCK PANEL

**VIS-295/GRF**

11290499A

Visor

152(W) x 144(H) mm

**MP/GRF**

11229509A

Surface box

144(W) x 144(H) x 45(D) mm

**MP-VIS/GRF**

11290496A

Surface box with rainshield

157(W) x 153(H) x 36(D) mm

**MAC-295/P**

11295611

Replacement frame

200(W) x 200(H) mm

**MAC-295/G**

11295615

Replacement frame

200(W) x 300(H) mm

**K-201 GRF**

11242014B

1-way kit

11229511A PE-295/1 GRF 1 push-button panel

11290290 Embedding box M

11205500P T-500 Tekna telephone

20691040 TF-104 transformer

x6

K6-201 GRF

11242016B

Pack of 6 kits K-201 GRF

**K-202 GRF**

11242024B

Kit for 2 apartments

11229512A PE-295/2 GRF 2 push-buttons panel

11290290 Embedding box M

11205500P 2x Tekna T-500 telephones

20691040 TF-104 transformer

x2



Nexa

AUDIO DOOR ENTRY KITS

modular flush mounting panel

NEXA ALUMINIUM panel

Anodised aluminium front

Illuminated indicators and prompt messages of the different system status

Illuminated card holders and stainless steel covered call buttons

Relay outputs for activation of two doors

Use with 12VDC door lock

Dimensions:

1 and 2 apartment kits (1 module height)

Exterior: 128(W) x 153(H) mm.

Embedded: 99(W) x 133(H) x 56(D) mm.

Kits from 3 to 12 apartments (2 modules high)

Exterior: 128(W) x 256(H) mm.

Embedded: 99(W) x 238(H) x 56(D) mm.

Kits from 14 to 22 apartments (3 modules high)

Exterior: 128(W) x 358(H) mm.

Embedded: 99(W) x 328(H) x 56(D) mm.



T-ART LITE

Housing made of polished ABS plastic in white colour

Removable handset telephone cord with connectors

Capacitive push-buttons with acoustic push confirmation

Selectable ring tones and do not disturb function with light indication

Output for auxiliary call repeater

Input for doorbell call button

Dimensions with terminal connector: 86(W) x 154(H) x 31(D) mm.

N4101/T-ART

12404101

1-way kit

- Nexa Aluminium 1 push-button panel
- 11880902A NCEV-90CS embedding box
- 12210101 T-ART LITE/G2+ telephone
- 12240100 FA-G2+ power supply



N4202/T-ART

12404202

Kit for 2 apartments

- Nexa Aluminium 2 push-buttons panel
- 11880902A NCEV-90CS embedding box
- 12210101 2x T-ART LITE/G2+ telephones
- 12240100 FA-G2+ power supply



N4204/T-ART

12404204

Kit for 4 apartments

- Nexa Aluminium 4 push-button panel
- 11880900 NCEV-90C embedding box
- 12210101 4x T-ART LITE/G2+ telephones
- 12240100 FA-G2+ power supply



N4206/T-ART

12404206

Kit for 6 apartments

- Nexa Aluminium panel with 6 push-buttons
- 11880900 NCEV-90C embedding box
- 12210101 6x T-ART LITE/G2+ telephones
- 12240100 FA-G2+ power supply



N4208/T-ART

12404208

Kit for 8 apartments

- Nexa Aluminium 8 push-buttons panel
- 11880900 NCEV-90C embedding box
- 12210101 8x T-ART LITE/G2+ telephones
- 12240100 FA-G2+ power supply

**N4210/T-ART**

12404210

Kit for 10 apartments

- Nexa Aluminium 10 push-buttons panel
- 11880900 NCEV-90C embedding box
- 12210101 10x T-ART LITE/G2+ telephones
- 12240100 FA-G2+ power supply

**N4212/T-ART**

12404212

Kit for 12 apartments

- Nexa Aluminium 12 push-buttons panel
- 11880900 NCEV-90C embedding box
- 12210101 12x T-ART LITE/G2+ telephones
- 12240100 FA-G2+ power supply

**N4214/T-ART**

12404214

Kit for 14 apartments

- Nexa Aluminium 14 push-buttons panel
- 11259906 CEV-90 Embedding box
- 12210101 14x T-ART LITE/G2+ telephones
- 12240100 FA-G2+ power supply



N4216/T-ART

12404216

Kit for 16 apartments

- Nexa Aluminium 16-button panel
- 11259906 CEV-90 Embedding box
- 12210101 16x T-ART LITE/G2+ telephones
- 12240100 FA-G2+ power supply



N4218/T-ART

12404218

Kit for 18 apartments

- Nexa Aluminium 18-button panel
- 11259906 CEV-90 Embedding box
- 12210101 18x T-ART LITE/G2+ telephones
- 12240100 FA-G2+ power supply



N4220/T-ART

12404220

Kit for 20 apartments

- Nexa Aluminium 20-button panel
- 11259906 CEV-90 Embedding box
- 12210101 20x T-ART LITE/G2+ telephones
- 12240100 FA-G2+ power supply



N4222/T-ART

12404222

Kit for 22 apartments

- Nexa Aluminium 22 push-buttons panel
- 11259906 CEV-90 Embedding box
- 12210101 22x T-ART LITE/G2+ telephones
- 12240100 FA-G2+ power supply



ACCESSORIES NEXA PANEL

RAINSHIELDS

	N711/AL	11880711	1 height	134(W) x 156(H) mm
	N721/AL	11880721	2 heights	134(W) x 259(H) mm
	N731/AL	11880731	3 heights	134(W) x 361(H) mm

SURFACE BOXES

	N811/AL	11880811	1 height	134(W) x 156(H) x 43(D) mm
	N821/AL	11880821	2 heights	134(W) x 259(H) x 43(D) mm
	N831/AL	11880831	3 heights	134(W) x 361(H) x 43(D) mm

SURFACE BOXES WITH INTEGRATED RAINSHIELD

	N871/AL	11880871	1 height	134(W) x 156(H) x 58(D) mm
	N872/AL	11880872	2 heights	134(W) x 259(H) x 58(D) mm
	N873/AL	11880873	3 heights	134(W) x 361(H) x 58(D) mm

45° SURFACE BOXES

	N911/AL	11280912	1 height	128(W) x 152(H) x 140(D) mm
	N921/AL	11280913	2 heights	128(W) x 254(H) x 140(D) mm
	N931/AL	11280914	3 heights	128(W) x 357(H) x 140(D) mm

REPLACEMENT FRAMES

	N611/AL	11880620	1 height	200(W) x 278(H) mm
	N611/AL-C	11880624	1 height	150(W) x 230(H) mm
	N621/AL	11880621	2 heights	200(W) x 430(H) mm
	N621/AL-C	11880623	2 heights	150(W) x 330(H) mm
	N631/AL	11890631	3 heights	200(W) x 512(H) mm
	N631/AL-C	11890633	3 heights	150(W) x 430(H) mm

NEW

Nexa

AUDIO DOOR ENTRY KITS

compact flush-mounted panel



NEXA ALUMINIUM panel

Anodised aluminium front

Illuminated indicators and prompt messages of the different system status

Illuminated card holders and stainless steel covered call buttons

To be used with 12VAC door opener.

Dimensions:

Kits for 1 and 2 apartments

Exterior: 128(W) x 153(H) mm.

Embedded: 99(W) x 133(H) x 56(D) mm.

Kits from 3 to 12 apartments

Exterior: 128(W) x 256(H) mm.

Embedded: 99(W) x 238(H) x 56(D) mm.

**TEKNA T-500** telephone

Housing made of polished ABS plastic in white colour

Removable handset telephone cord with connectors

Electronic call

Mechanical push-button for door opening

Dimensions: 86(W) x 220(H) x 56(D) mm.

**N4110/T-500**

11854110

1-way kit

Nexa Aluminium 1 push-button panel

11880902A NCEV-90CS embedding box

11205500P Tekna T-500 telephone

20691040 TF-104 transformer

**N4220/T-500**

11854220

Kit for 2 apartments

Nexa Aluminium 2 push-buttons panel

11880902A NCEV-90CS embedding box

11205500P 2x Tekna T-500 telephones

20691040 TF-104 transformer



N4130/T-500 11854130

Kit for 3 apartments

Nexa Aluminium 3 push-buttons panel

11880900 NCEV-90C embedding box

11205500P 3x Tekna T-500 telephones

20691040 TF-104 transformer



N4140/T-500 11854140

Kit for 4 apartments

Nexa Aluminium 4 push-button panel

11880900 NCEV-90C embedding box

11205500P 4x Tekna T-500 telephones

20691040 TF-104 transformer



N4150/T-500 11854150

Kit for 5 apartments

Nexa Aluminium 5 push-buttons panel

11880900 NCEV-90C embedding box

11205500P 5x Tekna T-500 telephones

20691040 TF-104 transformer



N4160/T-500 11854160

Kit for 6 apartments

Nexa Aluminium 6 push-buttons panel

11880900 NCEV-90C embedding box

11205500P 6x Tekna T-500 telephones

20691040 TF-104 transformer



N4280/T-500 11854280

Kit for 8 apartments

Nexa Aluminium 8 push-buttons panel

11880900 NCEV-90C embedding box

11205500P 8x Tekna T-500 telephones

20691040 TF-104 transformer



N4210/T-500 11854210

Kit for 10 apartments

Nexa Aluminium 10 push-buttons panel

11880900 NCEV-90C embedding box

11205500P 10x Tekna T-500 telephones

20691040 TF-104 transformer

**N4212/T-500**

11854212

Kit for 12 apartments

Nexa Aluminium 12 push-buttons panel

11880900 NCEV-90C embedding box

11205500P 12x Tekna T-500 telephones

20691040 TF-104 transformer

ACCESSORIES NEXA PANEL

RAINSHIELDS

**N711/AL**

11880711

1 height

134(W) x 156(H) mm

N721/AL

11880721

2 heights

134(W) x 259(H) mm

SURFACE BOXES

**N811/AL**

11880811

1 height

134(W) x 156(H) x 43(D) mm

N821/AL

11880821

2 heights

134(W) x 259(H) x 43(D) mm

SURFACE BOXES WITH INTEGRATED RAINSHIELD

**N871/AL**

11880871

1 height

134(W) x 156(H) x 58(D) mm

N872/AL

11880872

2 heights

134(W) x 259(H) x 58(D) mm

45° SURFACE BOXES

**N911/AL**

11280912

1 height

128(W) x 152(H) x 140(D) mm

N921/AL

11280913

2 heights

128(W) x 254(H) x 140(D) mm

REPLACEMENT FRAMES

**N611/AL**

11880620

1 height

200(W) x 278(H) mm

N611/AL-C

11880624

1 height

150(W) x 230(H) mm

N621/AL

11880621

2 heights

200(W) x 430(H) mm

N621/AL-C

11880623

2 heights

150(W) x 330(H) mm

Nexa

ACCESS CONTROL KITS

KEYPAD

Anodised aluminium front

White backlit keypad with stainless steel covered push-buttons

Exit push-button inputs can be deactivated by programmable code

Programmable activation time (1 to 99 seconds) and output mode (pulse or steady)

1.000 4-, 5- or 6-digit codes. Each code can be programmed to activate a combination of outputs

User codes and special codes can be changed without accessing programming mode

Programmable blocking feature for a period of time after entering several consecutive wrong codes

Relay outputs for activation of two doors and 12VDC panic output.

Module tamper alarm (tamper)

Dimensions:

Exterior: 128(W) x 153(H) mm.

Embedded: 99(W) x 133(H) x 56(D) mm.



PROXIMITY READER NFC

Anodised aluminium front

Light and acoustic indicators of operation

Programmable activation time (3 to 99 seconds)

Up to 2,000 user cards, stored in up to 32 user groups

Possibility of opening from an Android® phone with NFC technology using the OpenGo app

Relay outputs for activation of two doors

Panic output 12Vdc.

Module tamper alarm (tamper)

Dimensions:

Exterior: 128(W) x 153(H) mm.

Embedded: 99(W) x 133(H) x 56(D) mm.





N4301/AL

11884301

Stand-alone access control kit with numeric keypad

- 11883301 N3301/AL Access control module
- 11880601 N6001/AL Mounting kit
- 11880902A NCEV-90CS embedding box
- 20691040 TF-104 transformer
- 20600155 CV-14P/UNI/SF door lock
- 20690055 ESCUDO M/G for door lock release



N4502/NFC

11884502

Stand-alone access control kit by proximity reader with NFC technology

- 11814502 Proximity reader module EL4502/NFC
- 11883002 Module with large information display N3002/AL
- 11812100 5x NFC/US user cards
- 11880601 N6001/AL mounting kit
- 11880902A NCEV-90CS embedding box
- 20691040 TF-104 transformer
- 20600155 Door lock CV-14P/UNI/SF
- 20690055 ESCUDO M/G for door lock release

ACCESSORIES NEXA ACCESS CONTROL KITS

VISOR



N711/AL
11880711
134(W) x 156(H) mm

SURFACE BOX



N811/AL
11880811
134(W) x 156(H) x 43(D) mm

SURFACE BOX WITH INTEGRATED RAINSHIELD



N871/AL
11880871
134(W) x 156(H) x 58(D) mm

45° ANGLED SURFACE BOX



N911/AL
11280912
128(W) x 152(H) x 140(D) mm

REPLACEMENT FRAMES



N611/AL
11880620
200(W) x 278(H) mm



N611/AL-C
11880624
150(W) x 230(H) mm

KEY FOBs AND CARDS



TAGNFC/US
11812125
User proximity key fob



NFC/US
11812100
User card



NFC/IN
11812105
Installer card for reader programming



panels

⚙ SUPRA 58

⚙ SIXTY5 66

Sixty5 Touch 66

Sixty5 Code 70

NEXA 74

Modular panel 74

Replacement 86

Custom 88

⚙ ARTIS 90

NEW

supra

| modular panel

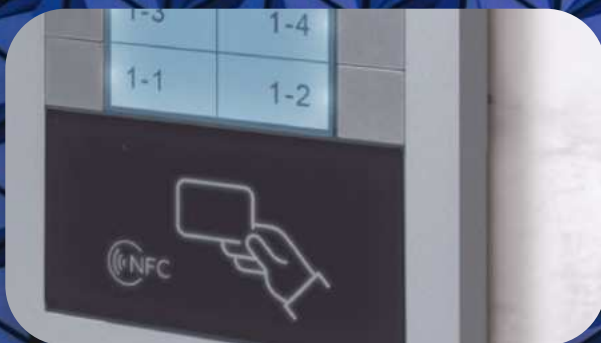

- ▶ **Vandal-proof (IK08) and weather resistant (IP65) panel** with zamak frame and die-cast aluminium frame for high robustness. Available in natural aluminium or black colour.
- ▶ **Easy assembly and connection** by means of plug-in modules and connecting cables. Vertical tilting of the panel.
- ▶ **AISI316 stainless steel** modules, and push-button modules with white LEDs of variable intensity according to exterior lighting conditions. High resistance polycarbonate camera protection window.
- ▶ **2Mpx HD camera** with **150° wide angle** lens and **HDR sensor** for backlight compensation. **Ten zoom areas** allow the best viewing angle digitally selected.
- ▶ **Illuminated indicators and voice prompts**, of the different system status, facilitate access for visually and hearing impaired users. optional **Inductive amplifier module** for visitors with hearing aids.
- ▶ Push-button modules with **automatic assignment of call codes**.
- ▶ **Local programming** by the push-buttons on the panel **or via Wi-Fi** through the internal web server.
- ▶ **2 relay outputs for doors**, with independent inputs for remote activation.
- ▶ **Access control modules** via keypad, NFC proximity reader and 2SAFE, compatible with EASYGATE and iP-Opener access controls.
- ▶ "G2+" 2-wire non-polarised technologies and for direct replacement of Golmar "Plus" (3 + coaxial or 4 + twisted pair) and "Vista Plus/R5" (5-wire) video door entry panels. *(Check spare parts list)*
- ▶ Ideal for the **replacement of Golmar Studio panels** without the need to change the embedding box.
- ▶ Panel dimensions:
 - 1 height - 134(W) x 155(H) mm
 - 2 heights - 134(W) x 271(H) mm
 - 3 heights - 134(W) x 388(H) mm
 - 4 heights - 134(W) x 495(H) mm



finishes



2

finishes

aluminium and black

150°

wide angle
camerawith digital zoom
selectionWi-Fi
integrated

for easy programming

IP65
IK08

ratings

waterproof and
vandal-resistant

To configure a door entry panel

- ▶ Choose a panel colour: aluminium (/AL) or black (/BK).
- ▶ Select a video module S1xxx or audio module S2xxx. Add an EL742 audio or EL732 video module according to the technology to be used.
- ▶ If a push-button panel is desired:
 - ▶ Add S3xxx push-button modules until the desired number of push-buttons is completed. Each push-button module must be accompanied by its corresponding EL706D electronic module.
- ▶ If a coded panel is desired, choose one of the following modules depending on the calling method:
 - ▶ S3302 numeric keypad, or
 - ▶ Display module with S3403 navigation buttons, or
 - ▶ The combination of the above.
- ▶ When using the display module it will also be possible to add the alphabetic keypad module S3303.
- ▶ Add informative window module S3001 if it is preferred in addition to the display module, so that the calling instructions, as well as the codes of the apartments can be found directly.
- ▶ It is also possible to use push-button modules in combination with coded panels to directly call specific apartments or guard units.
- ▶ If an access control system is required, select one from the pages 61 and 62.
- ▶ The maximum number of 1 height modules placed vertically is four, and eight in the case of half-height modules. The number of modules placed horizontally is unlimited.
- ▶ Select an embedding box and an S600x mounting frame according to the number of modules placed vertically.
- ▶ For panels with more than one horizontal module, order as many S600x embedding boxes and mounting frames as there are horizontal modules on the panel. Use UC cable tunnels and RAP-SUPRA cables to link them together (page 63).

VIDEO / AUDIO MODULES



S1000/AL 12581000

● **S1000/BK** 12581000B

Video module
Without push-buttons
1 height



S1110/AL 12581110

● **S1110/BK** 12581110B

Video module
1 push-button
1 height



S1220/AL 12581220

● **S1220/BK** 12581220B

Video module
2 push-buttons
1 height

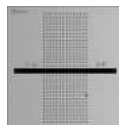

S2000/AL 12582000

● **S2000/BK** 12582000B

Audio module
Without push-buttons
1 height



S2110/AL 12582110

Audio module
1 push-button
1 height

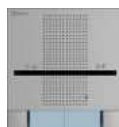

S2220/AL 12582220

● **S2220/BK** 12582220B

Audio module
2 push-buttons
1 height



▶ **EL732/G2+** 12580732

Sound module with colour camera
2 push-buttons
1 height



▶ **EL742/G2+** 12580742

Sound module
2 push-buttons
1 height

PUSH-BUTTONS MODULES

**S3120/AL** 125831202 push-buttons
½ height**S3130/AL** 125831303 push-buttons
½ height**S3240/AL** 12583240● **S3240/BK** 12583240B4 push-buttons
½ height**S3260/AL** 12583260● **S3260/BK** 12583260B6 push-buttons
½ height**EL706D** 12580706Electronic push-button module
For 3 single or 6 double push-buttons
½ height

INFO / BLIND / ILA MODULE

**S3000/AL** 12583000● **S3000/BK** 12583000BBlind module
½ heightGolmar
Street**S3001** 12583001Informative window module without
illumination
½ heightGolmar
Street**S3001/S** 12583001SInformative window module with
illumination
½ height**S3001/H** 12583001HInductive loop amplifier module
For hearing aids with "T" mode
½ height

CODED DISPLAY MODULES

**S3403/AL** 125834033.5" TFT display module
Backlit navigation keys
1 height**S3302/AL** 12583302Backlit numeric call keypad module
Includes access control function
1 height**S3303/AL** 12583303Backlit alphabetic keypad module
Letters from A to P
Allows to assign one or more letters to the
apartment call address
Requires modules S3403/AL and S3302/AL
1 height

ACCESS CONTROL MODULE WITH KEYPAD

**S3301/AL** 12583301Stand-alone access control module with keypad
Programming via keypad or via Wi-Fi through
internal web serverAcoustic push-button confirmation tone
deactivatable and operation indicator lights**1.000 4-, 5- or 6-digit** codes. Each code can be
programmed to activate a combination of outputs
User codes and special codes can be changed
without accessing programming modeProgrammable access control deactivation for a
period of time after consecutive wrong codes are
entered**2 relay outputs** (NO, C, NC) for doors, with
separate inputs for remote activationProgrammable activation time (1 to 99 seconds)
and output mode (pulse or steady)

Tamper alarm and panic output

12V a.c. or 18 to 24V d.c. power supply. It is
possible to use the power supply of the outdoor
panel

1 height

ACCESS CONTROL MODULE WITH PROXIMITY READER



S3501/NFC

12583501

Stand-alone access control module with 13,56MHz NFC reader

Basic programming via local micro-switch and light and acoustic indicators **or via Wi-Fi** through internal web server (requires NFC/IN installer card)

Up to 2,000 user cards stored in up to 30 user groups
Smartphones with Android™ operating system and NFC technology can work with this access control using the OpenGo app available on Google's Play Store

Compatible with NFC/US cards and TAGNFC/US key fobs

2 relay outputs (NO, C, NC) for doors, with separate inputs for remote activation

Programmable activation time (3 to 99 seconds)

Tamper alarm and panic output

12VAC or 18 to 24VDC power supply. It is possible to use the power supply of the outdoor panel

½ height



NFC/IN

11812105

Installer card for Wi-Fi programming



NFC/US

11812100

13,56MHz user card



TAGNFC/US

11812125

13,56MHz user key fob

DUAL ACCESS CONTROL MODULES



S3000/BIO-N

12583315

● **S3000/BIO-N/BK**

12583315B

Stand-alone access control module using fingerprint and 125KHz reader

Capacitive fingerprint sensor

Wiegand 26 output for connection to access control modules

Light and acoustic indicator of operation

Up to 899 user cards and 99 fingerprints

Optional access control deactivation after 10 consecutive wrong fingerprint entries

Compatible with PROKEY ID cards and TAGKEY ID key fobs

1 relay output (NO, C, NC) for door, with input for remote activation

Programmable activation time (1 to 99 seconds) and output mode (pulse or steady)

Tamper alarm

12 or 18V d.c. power supply.

1 height



S3000/CODEPROX-N

12583305

● **S3000/CODEPROX-N/BK**

12583305B

Stand-alone access control module with numeric keypad and 125KHz reader

Wiegand 26 output for connection to access control modules

Light and acoustic indicator of operation

Up to 990 users between codes and cards
4, 5 or 6 digit codes

Optional deactivation of access control after entering 10 consecutive wrong codes

Compatible with PROKEY ID cards and TAGKEY ID key fobs

1 relay output (NO, C, NC) for door, with input for remote activation

Programmable activation time (1 to 99 seconds) and output mode (pulse or steady)

Tamper alarm

12 or 18V d.c. power supply.

1 height



PROKEY ID

20710008

125KHz user card



TAGKEY ID

20710007

125KHz user key fob

MOUNTING FRAMES



S6001/AL 12586001

● **S6001/BK** 12586001B

Mounting frame for 1 height panels
134(W) x 155(H) mm

S6002/AL 12586002

● **S6002/BK** 12586002B

Mounting frame for 2 heights panels
134(W) x 271(H) mm

S6003/AL 12586003

● **S6003/BK** 12586003B

Mounting frame for 3 heights panels
134(W) x 388(H) mm

S6004/AL 12586004

● **S6004/BK** 12586004B

Mounting frame for 4 heights panels
134(W) x 495(H) mm

FLUSH-MOUNTED BOXES



CE610 11280610

Embedding box for 1 height panels
125(W) x 140(H) x 56(D) mm

CE620 11280620

Embedding box for 2 heights panels
125(W) x 257(H) x 56(D) mm

CE630 11280630

Embedding box for 3 heights panels
125(W) x 374(H) x 56(D) mm

CE640/SUPRA 12570950

Embedding box for 4 heights panels
121(W) x 484(H) x 56(D) mm

UC 11259990

Pack of 3 cable tunnels
To link boxes CE610, CE620 and CE630

UC-CE640/SUPRA 12590100

Pack of 3 cable tunnels
To link boxes CE640/SUPRA

RAP-SUPRA 12590850

85cm link cable
For connecting electronic modules of
different mounting frames

SURFACE-MOUNTED EMBEDDING BOXES WITH RAINSHIELD

S871/AL

12570871

● **S871/BK**

12570871B

Surface box with rainshield
For 1 height panels
140(W) x 161(H) x 48(D) mm

S873/AL

12570873

● **S873/BK**

12570873B

Surface box with rainshield
For 3 heights panels
140(W) x 395(H) x 48(D) mm

S872/AL

12570872

● **S872/BK**

12570872B

Surface box with rainshield
For 2 heights panels
140(W) x 278(H) x 48(D) mm

S874/AL

12570874

● **S874/BK**

12570874B

Surface box with rainshield
For 4 heights panels
140(W) x 500(H) x 48(D) mm



RAINSHIELDS

S711/AL

12570711

● **S711/BK**

12570711B

Rainshield for 1 height panels
139(W) x 159(H) mm

S722/AL

12570722

● **S722/BK**

12570722B

Rainshield for 2 panels of 2 heights
274(W) x 276(H) mm

S721/AL

12570721

● **S721/BK**

12570721B

Rainshield for 2 panels of 2 heights
139(W) x 276(H) mm

S723/AL

12570723

● **S723/BK**

12570723B

Rainshield for 3 panels of 2 heights
408(W) x 276(H) mm

S731/AL

12570731

● **S731/BK**

12570731B

Rainshield for 3 heights panels
139(W) x 393(H) mm

S732/AL

12570732

● **S732/BK**

12570732B

Rainshield for 2 panels of 3 heights
274(W) x 393(H) mm

S741/AL

12570741

● **S741/BK**

12570741B

Rainshield for 4 heights panels
139(W) x 500(H) mm

S733/AL

12570733

● **S733/BK**

12570733B

Rainshield for 3 panels of 3 heights
408(W) x 393(H) mm



CORNER SURFACE BOXES



S911/AL 12570911

● **S911/BK** 12570911B

45° angle surface box
For 1 height panels
139(W) x 155(H) x 115(D) mm

S921/AL 12570921

● **S921/BK** 12570921B

45° angle surface box
For 2 heights panels
139(W) x 272(H) x 115(D) mm

S931/AL 12570931

● **S931/BK** 12570931B

45° angle surface box
For 3 heights panels
139(W) x 389(H) x 115(D) mm

S941/AL 12570941

● **S941/BK** 12570941B

45° angle surface box
For 4 heights panels
139(W) x 496(H) x 210(D) mm

S922/AL 12570922

● **S922/BK** 12570922B

45° angle surface box
For 2 panels of 2 heights
274(W) x 272(H) x 210(D) mm

S932/AL 12570932

● **S932/BK** 12570932B

45° angle surface box
For 2 panels of 3 heights
274(W) x 389(H) x 210(D) mm

REPLACEMENT FRAMES



S611/AL 12570611

Replacement frame
For 1 height panels
200(W) x 278(H) mm

S621/AL 12570621

Replacement frame
For 2 heights panels
200(W) x 430(H) mm

S631/AL 12570631

Replacement frame
For 3 heights panels
200(W) x 512(H) mm

S641/AL 12570641

Replacement frame
For 4 heights panels
200(W) x 620(H) mm

S622/AL 12570622

Replacement frame
For 2 panels of 2 heights
334(W) x 430(H) mm

S632/AL 12570632

Replacement frame
For 2 panels of 3 heights
334(W) x 512(H) mm

S633/AL 12570633

Replacement frame
For 3 panels of 3 heights
468(W) x 512(H) mm

NEW

Sixty5

TOUCH

vandal-resistant panel with
touch screen display





- ▶ **Technologies** "G2+" two-wire non-polarised or IP G+.
- ▶ **Vandal-resistant (IK10) and waterproof (IP65) panel** made of 6 mm thick anodised aluminium in natural or black colours, or polished AISI316 stainless steel with mirror finish.
- ▶ **2Mpx HD camera** with 130° wide **angle lens** and white LEDs of variable intensity depending on the outdoor lighting conditions.
- ▶ **7" TFT LCD touch screen** with 600 x 1024 px resolution, protected by 4 mm thick tempered glass.
- ▶ **Presence and illumination** sensors.
- ▶ **Inductive loop amplifier** for users with hearing aids.
- ▶ **Tamper alarm.**
- ▶ **Modular graphic interface** available in two designs: original and dark mode. Direct functions customizable according to user needs: direct call to concierge, push-button for deliveries, access control, agenda...
- ▶ **Local programming** through on-screen menus or through internal web server. **Remote** programming through the "Sixty5 cloud" portal, which allows editing access codes, proximity cards or agenda names.
- ▶ **Access control** via keypad and proximity reader, with antennas available in 125 KHz, 13,56 Mhz and 2SAFE (compatible with EASYGATE and iP-Opener access controls) and Wiegand26 output.
- ▶ Door opening with **double PIN+RFID security** (optional).
- ▶ **Customizable welcome image** and optional on-screen visitor display.
- ▶ **Voice prompts and on-screen messages** of the system status in different languages.
- ▶ **Several calling methods:** entry of the code of the apartment to be called, search in the agenda, virtual push-buttons panel mode, ... The "villa" mode allows you to make a direct call to an apartment by simply pressing the bell button.
- ▶ **2 relay outputs** for doors, with independent inputs for remote activation.
- ▶ **Daily backup** of user and configuration data on microSD card.
- ▶ Dimensions:
 - Exterior: 155(W) x 318(H) x 5(D) mm
 - Embedded: 132(W) x 308(H) x 46(D) mm



finishes



ALUMINIUM



BLACK

INOX
MIRROR

3

finishes

natural aluminium, black or stainless steel

130°

2Mpx
HD camera

7"

TFT LCD
touch screenwith tempered glass
protectionIP65
IK10

ratings

waterproof and
vandal-resistant

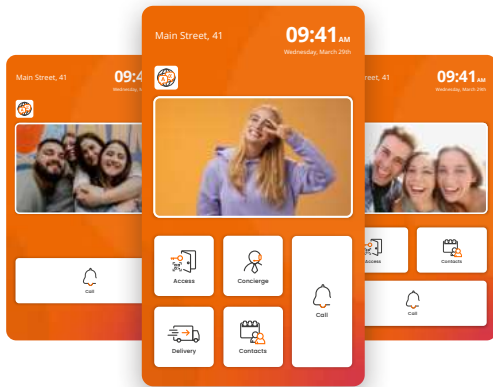

◀ A customised home page.

An easy and intuitive menu allows you to customize the home page, adapting the panel to the needs of each installation and user. From a simple call button for a single-family house, **up to 5 functions** including all the call and home access control options.

More ways to call.

Sixty5 Touch allows you to choose three different ways to make the call. Using an **on-screen keypad** to dial the apartment dial code number, either numeric or including letters. By choosing a contact from the **agenda**, which can also include information about the contact, such as a photograph, a company logo or even a personalized message. For more traditional users, the panel can display up to 32 **virtual push-buttons** on the screen, making it possible to call as if it were a conventional push-buttons panel.



▶ Remote management.

Connect the panel to the Internet to fully enjoy all the features that this panel offers. Now it will no longer necessary to go to the installation to change the name of an apartment, remove a name from the agenda or give access to open the door. Golmar's "Sixty5 Cloud" portal allows you to access the panel remotely, from any browser, in a simple and intuitive way.



2-wire non-polarised installation

G2⁺

12226507A



12226507B



12226507X

6507/G2+Anodised aluminium touch panel
2-wire technology
13,56MHz reader**6507/G2+ BLACK**Black anodised aluminium touch panel
2-wire technology
13,56MHz reader**6507/G2+ INOX**AISI316 stainless steel touch panel
2-wire technology
13,56MHz reader**6507/G2+/125KHZ**

12226507A1

6507/G2+/125KHZ BLACK

12226507B1

6507/G2+/125KHZ INOX

12226507X1

Anodised aluminium touch panel
2-wire technology
125KHz readerBlack anodised aluminium touch panel
2-wire technology
125KHz readerAISI316 stainless steel touch panel
2-wire technology
125KHz reader**6507/G2+/2SAFE**

12226507A2

6507/G2+/2SAFE BLACK

12226507B2

6507/G2+/2SAFE INOX

12226507X2

Anodised aluminium touch panel
2-wire technology
2SAFE reader
Compatible with iP-Opener and EASYGATEBlack anodised aluminium touch panel
2-wire technology
2SAFE reader
Compatible with iP-Opener and EASYGATEAISI316 stainless steel touch panel
2-wire technology
2SAFE reader
Compatible with iP-Opener and EASYGATE

Installation with TCP/IP protocol

iPG⁺**6507/G+**

12326507A

6507/G+ BLACK

12326507B

6507/G+ INOX

12326507X

Anodised aluminium touch panel
IP G+ technology
13,56MHz readerBlack anodised aluminium touch panel
IP G+ technology
13,56MHz readerAISI316 stainless steel touch panel
IP G+ technology
13,56MHz reader**6507/G+/2SAFE**

12326507A2

6507/G+/2SAFE BLACK

12326507B2

6507/G+/2SAFE INOX

12326507X2

Anodised aluminium touch panel
IP G+ technology
2SAFE reader
Compatible with iP-Opener and EASYGATEBlack anodised aluminium touch panel
IP G+ technology
2SAFE reader
Compatible with iP-Opener and EASYGATEAISI316 stainless steel touch panel
IP G+ technology
2SAFE reader
Compatible with iP-Opener and EASYGATE

ALUMINIUM
 BLACK
 INOX MIRROR

Sixty5

CODE

coded vandal-resistant panel





- ▶ **Technologies** "G2+" two-wire non-polarised or IP G+.
- ▶ **Vandal-proof (IK07) and waterproof (IP65) panel** made of 5 mm thick anodised aluminium in natural or black colours, or polished AISI316 stainless steel with mirror finish.
- ▶ **2Mpx HD camera** with 130° wide **angle lens** and white LEDs of variable intensity depending on the outdoor lighting conditions.
- ▶ **Widescreen display** 4.3" TFT LCD with 480 x 272 px resolution in panoramic 16:9 format.
- ▶ **Metallic backlit push-buttons** with acoustic push beep tone confirmation.
- ▶ **Presence and illumination** sensors.
- ▶ **Inductive loop amplifier** for users with hearing aids.
- ▶ **Tamper alarm.**
- ▶ **Local programming** through on-screen menus or through internal web server. **Remote** programming through the "Sixty5 cloud" portal, which allows editing access codes, proximity cards or names in the agenda.
- ▶ **Access control** via keypad and proximity reader, with antennas available in 125 KHz, 13,56 Mhz and 2SAFE (compatible with EASYGATE and iP-Opener access controls) and Wiegand26 output.
- ▶ Door opening with **double PIN+RFID security** (optional).
- ▶ **Customisable welcome image** and optional on-screen visitor display.
- ▶ Displays the **visitor on screen** in panoramic format, adding a layer of user security and comfort.
- ▶ **Voice and on-screen** system status messages in different languages.
- ▶ **Two calling methods:** entering the apartment code or searching in the agenda. The "villa" mode allows a direct call to an apartment by simply pressing the bell button.
- ▶ **Direct call to the concierge button .**
- ▶ **2 relay outputs for doors**, with independent inputs for remote activation.
- ▶ **Daily backup** on microSD card of user and configuration data.
- ▶ Dimensions:
Exterior: 155(W) x 318(H) x 5(D) mm
Embedded: 132(W) x 308(H) x 46(D) mm



finishes



ALUMINIUM

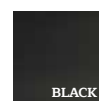

BLACK

INOX
MIRROR

3

finishes

natural aluminium, black or stainless steel

130°

2Mpx
HD camera

4,3"

widescreen
TFT LCD displayIP65
IK07

indexes

waterproof and
vandal-resistant

2-wire non-polarised installation

G2+



6502/G2+	12226502A	6502/G2+ BLACK	12226502B	6502/G2+ INOX	12226502X
Anodised aluminium coded panel 2-wire technology 13,56MHz reader		Black anodised aluminium coded panel 2-wire technology 13,56MHz reader		AISI316 stainless steel coded panel 2-wire technology 13,56MHz reader	
6502/G2+/125KHZ	12226502A1	6502/G2+/125KHZ BLACK	12226502B1	6502/G2+/125KHZ INOX	12226502X1
Anodised aluminium coded panel 2-wire technology 125KHz reader		Black anodised aluminium coded panel 2-wire technology 125KHz reader		AISI316 stainless steel coded panel 2-wire technology 125KHz reader	
6502/G2+/2SAFE	12226502A2	6502/G2+/2SAFE BLACK	12226502B2	6502/G2+/2SAFE INOX	12226502X2
Anodised aluminium coded panel 2-wire technology 2SAFE reader Compatible with iP-Opener and EASYGATE		Black anodised aluminium coded panel 2-wire technology 2SAFE reader Compatible with iP-Opener and EASYGATE		AISI316 stainless steel coded panel 2-wire technology 2SAFE reader Compatible with iP-Opener and EASYGATE	

Installation with TCP/IP protocol

iPG+

6502/G+	12326502A	6502/G+ BLACK	12326502B	6502/G+ INOX	12326502X
Anodised aluminium coded panel IP G+ Technology 13,56MHz reader		Black anodised aluminium coded panel IP G+ Technology 13,56MHz reader		AISI316 stainless steel coded panel IP G+ Technology 13,56MHz reader	
6502/G+/2SAFE	12326502A2	6502/G+/2SAFE BLACK	12326502B2	6502/G+/2SAFE INOX	12326502X2
Anodised aluminium coded panel IP G+ Technology 2SAFE reader Compatible with iP-Opener and EASYGATE		Black anodised aluminium coded panel IP G+ Technology 2SAFE reader Compatible with iP-Opener and EASYGATE		AISI316 stainless steel coded panel IP G+ Technology 2SAFE reader Compatible with iP-Opener and EASYGATE	

● ALUMINIUM ● BLACK ■ INOX MIRROR

ACCESSORIES SIXTY5 PANELS



- **6502/INFO** 12226503A
- **6502/INFO BLACK** 12226503B
- **6502/INFO INOX** 12226503X

Informative module
155(W) x 317(H) x 50(D) mm



- **CE-6502 SE** 12396502B

Embedding box
132(W) x 308(H) x 45(D) mm



- **S7865 SE** 12397865A
- **S7865 SE BLACK** 12397865B

Rainshield
158(W) x 320(H) mm



- **S7865/INFO** 12397865A2
- **S7865/INFO BLACK** 12397865B2

Rainshield for panels with informative module
313(W) x 320(H) mm



- **S7165 SE** 12397165A
- **S7165 SE BLACK** 12397165B

Surface box with rainshield
158(W) x 320(H) x 50(D) mm

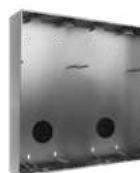

- **S7165/INFO** 12397165A2
- **S7165/INFO BLACK** 12397165B2

Surface-mounted box with rainshield for informative module panels
313(W) x 320(H) x 50(D) mm



- **UC-6502** 12396510

Set of 2 cable tunnels
To link 2 boxes CE-6502 SE



- **UC-6502/LARGE** 12396511

Cable tunnel
To link CE-6502 SE embedding boxes between 2 rainshields S7865

13,56MHz



- **NFC/US** 11812100

13,56MHz user card



- **TAGNFC/US** 11812125

13,56MHz user key fob

125KHz



- **PROKEY ID** 20710008

125KHz user card



- **TAGKEY ID** 20710007

125KHz user key fob

For cards and keyfobs for **Sixty5 panels with 2SAFE technology (iP-Opener and EASYGATE)**.
Check Access Control section on page 134

Nexa | modular panel



- ▶ **Anodised aluminium or AISI316 stainless steel** panel in natural colour.
- ▶ **Easy mounting and connection** by means of link cables.
- ▶ Information or camera display made of high-strength polycarbonate.
- ▶ Push-button modules with white LED lighting.
- ▶ **Access control modules** by means of keypad, NFC proximity reader and 2SAFE, compatible with EASYGATE and iP-Opener access controls.
- ▶ **Technologies** "G2+" 2-wire non-polarised, IP "G+" and analogue with 4+n installation.
- ▶ **In the modules with "G2+" or IP "G+" technology:**
 - ◆ **2Mpx HD pan and tilt camera** with **120° wide angle** lens and **HDR sensor** sensor for backlight compensation.
 - ◆ **Indicator lights and voice prompt messages of the different system** status facilitate access for visually and hearing impaired users. **Inductive amplifier module** optional for visitors with hearing aids.
 - ◆ **2 relay outputs** for doors, with independent inputs for remote activation.
 - ◆ Ideal for the **replacement of Golmar 90 Series** (aluminium panels with three height modules) **and Stadio Series** (stainless steel panels of any height) using the existing embedding box.

- ▶ Dimensions Nexa aluminium panel:

1 module	- 128(W) x 153(H) mm
2 modules	- 128(W) x 256(H) mm
3 modules	- 128(W) x 358(H) mm
4 modules	- 128(W) x 460(H) mm

- ▶ Dimensions Nexa Inox panel:

1 module	- 134(W) x 150(H) mm
2 modules	- 134(W) x 267(H) mm
3 modules	- 134(W) x 384(H) mm
4 modules	- 155(W) x 506(H) mm

finishes



2

finishes

anodised aluminium and stainless steel AISI316

120°

wide angle camera

and HDR sensor

Replacement
of Golmar panels

Series 90 and Stadio

To configure a door entry panel

- ▶ Select an N1xxx/AL, N2000/AL or NX1xxx module. Add an audio or video module according to the technology to be used.
- ▶ If a push-button panel is desired:
 - ▶ Add N3xxx or NX3xxx push-button modules to obtain the desired number of push-buttons. Each push-button module must be accompanied by its corresponding electronics: EL610A for 4+n technology equipment or EL610D or EL606D for other technologies.
- ▶ If a coded panel is desired (only available for G2+ technology equipment), use a CD-NEXA/G2+ digital converter and choose one of the following modules depending on the calling method:
 - ▶ N3301/AL or NX3301 numeric keypad
 - ▶ Display module with navigation buttons N3403/AL or NX3403
 - ▶ The combination of the above.
 - ▶ When using the display module, it is also possible to add the alphabetic keypad module N3301A/AL or NX3301A.
 - ▶ Add informative window modules N3002/AL or NX3002/AL if it is preferred in addition to the display, so that the call instructions as well as the apartment codes can be found directly.
 - ▶ It is also possible to use push-button modules in combination with coded panels to directly call specific apartments or guard units.
- ▶ If an access control system is required, select one from the pages 78 and 79.
- ▶ The maximum number of modules placed vertically is four, while the number of modules placed horizontally is unlimited.
- ▶ Select an embedding box and an N600x/AL or NX600x mounting kit depending on the number of modules placed vertically.
- ▶ For panels with more than one horizontal module:
 - ▶ For aluminium panels, order as many embedding boxes as there are horizontal modules on the panel. Use UC cable tunnels and N601x/AL mounting kits to connect them (pages 80 and 81).
 - ▶ For stainless steel panels, order as many NX600x embedding boxes and mounting kits as there are horizontal modules on the panel. Use UC cable tunnels to link them (pages 80 and 81).
 - ▶ Use a RAP-610A (4+N technology) or RAP-610D (all other technologies) cable to link the electronic modules of different embedding boxes.

AUDIO / VIDEO MODULES



● N1000/AL	11881000
■ NX1000	11761000C
Audio/video module Without push-buttons	



● N2000/AL	11882000
Audio module Without push-buttons	



● N1110/AL	11881110
■ NX1110	11761110C
Audio/video module 1 push-button	



● N1220/AL	11881220
■ NX1220	11761220C
Audio/video module 2 push-buttons	



▶ EL655	11818655
Sound module For systems with 1 panel Electronic or buzzer call 2 push-buttons	



▶ EL651 SE	11818651A
Sound module For systems with more than one panel Electronic call 2 push-buttons	



▶ EL632/G2+ SE	12225632A
▶ EL632/G+/48	12325632A
Sound module with colour camera 2 push-buttons	



▶ EL642/G2+	12235642
Sound module 2 push-buttons	

PUSH-BUTTONS MODULES



- **N3111/AL** 11883111
 - **NX3111** 11783111C
-
- 1 push-button



- **N3121/AL** 11883121
 - **NX3121** 11783121C
-
- 2 push-buttons



- **N3131/AL** 11883131
 - **NX3131** 11783131C
-
- 3 push-buttons



- **N3110/AL** 11883110
 - **NX3110** 11763110C
-
- 1 push-button



- **N3120/AL** 11883120
 - **NX3120** 11763120C
-
- 2 push-buttons



- **N3130/AL** 11883130
 - **NX3130** 11763130C
-
- 3 push-buttons



- **N3140/AL** 11883140
 - **NX3140** 11763140C
-
- 4 push-buttons



- **N3150/AL** 11883150
 - **NX3150** 11763150C
-
- 5 push-buttons



- **N3221/AL** 11883221
 - **NX3221** 11783221C
-
- 2 push-buttons



- **N3241/AL** 11883241
 - **NX3241** 11783241C
-
- 4 push-buttons



- **N3261/AL** 11883261
 - **NX3261** 11783261C
-
- 6 push-buttons



- **N3220/AL** 11883220
 - **NX3220** 11763220C
-
- 2 push-buttons



- **N3240/AL** 11883240
 - **NX3240** 11763240C
-
- 4 push-buttons



- **N3260/AL** 11883260
 - **NX3260** 11763260C
-
- 6 push-buttons



- **N3280/AL** 11883280
 - **NX3280** 11763280C
-
- 8 push-buttons



- **N3210/AL** 11883210
 - **NX3210** 11763210C
-
- 10 push-buttons



- ▲ **EL610A** 11818610
 - ▲ **EL610D** 11818612
-
- Electronic push-button module
For 5 single or 10 double push-buttons



- ▲ **EL606D** 12010606
-
- Electronic push-button module
For 3 single or 6 double push-buttons

INFO / BLIND / ILA MODULE



● **N3000/AL** 11883000

■ **NX3000** 11763000C

Blind module
Without push-buttons



● **N3001/AL** 11883001

■ **NX3001** 11763001C

Module with small informative window
Without push-buttons



● **N3002/AL** 11883002

■ **NX3002** 11763002C

Module with large informative window
Without push-buttons



● **EL3002** 11823002

Illumination module
For modules with large informative window



● **EL3002H** 11503002

Inductive Loop Amplifier module
For hearing aids with "T" mode
Requires informative module with large informative window

CODED DISPLAY MODULES

Only with G2+ technology



● **N3403/AL** 11883404

■ **NX3403** 11883405C

OLED display module
Backlit navigation and call button



● **N3301/AL** 11883301

■ **NX3301** 11883302C

Backlit numeric call keypad module
Includes access control function



● **N3301A/AL** 11885301

■ **NX3301A** 11886301C

Backlit alphabetic keypad module
Letters from A to L
Allows to assign one or more letters to the apartment call code
Requires N3403/AL and N3301A/AL or NX3403 and NX3301A modules



● **CD-NEXA/G2+** 12280615

Digital converter for coded panels

ACCESS CONTROL MODULE WITH KEYPAD



● **N3301/AL** 11883301

■ **NX3301** 11883302C

Stand-alone access control module with keypad

Keypad programming

Acoustic push-button confirmation tone deactivatable and operation indicator lights

1.000 4-, 5- or 6-digit 4, 5 or 6 digit codes. Each code can be programmed to activate a combination of outputs

User codes and special codes can be changed without accessing programming mode

Programmable access control deactivation for a period of time after consecutive wrong codes are entered

2 relay outputs (NO, C, NC) for doors, with independent inputs for remote activation

Programmable activation time (1 to 99 seconds) and output mode (pulse or steady)

Tamper alarm and panic output

12V a.c. or 18 to 24V d.c. power supply. It is possible to use the power supply of the outdoor panel



ACCESS CONTROL MODULE WITH PROXIMITY READER

**EL4502/NFC**

11814502

Stand-alone access control module with 13,56MHz NFC reader

For modules with large informative window
2 relay outputs for doors

Basic programming via local microswitch and indicator lights

Up to 2,000 user cards stored in up to 30 user groups
Smartphones with Android™ operating system and NFC technology can work with this access control using the OpenGo app available on Google's Play Store

Compatible with NFC/US cards and TAGNFC/US key fobs
Relays (NO, C, NC) with independent inputs for remote activation

Programmable activation time (3 to 99 seconds)

Tamper alarm and panic output

12VAC or 18 to 24VDC power supply. It is possible to use the power supply of the outdoor panel

**EL4503/NFC**

11814503

Stand-alone access control module with 13,56MHz NFC reader

For modules with small informative window
1 relay output for doors

**NFC/US**

11812100

13,56MHz user card

**TAGNFC/US**

11812125

13,56MHz user key fob

DUAL ACCESS CONTROL MODULES

**N3000/BIO-N**

20700015

NX3000/BIO-N

20700016

Stand-alone access control module using fingerprint and 125KHz reader

Capacitive fingerprint sensor

Wiegand 26 output for connection to access control modules

Light and acoustic indicator of operation

Up to 899 user cards and 99 fingerprints

Optional access control deactivation after 10 consecutive wrong fingerprint entries

Compatible with PROKEY ID cards and TAGKEY ID key fobs

1 relay output (NO, C, NC) for door, with input for remote activation

Programmable activation time (1 to 99 seconds) and output mode (pulse or steady)

Tamper alarm

12 or 18V d.c. power supply.

**N3000/CODEPROX-N**

20700017

NX3000/CODEPROX-N

20700018

Stand-alone access control module with numeric keypad and 125KHz reader

Wiegand 26 output for connection to access control modules

Light and acoustic indicator of operation

Up to 990 users between codes and cards

4, 5 or 6 digit codes

Optional locking of access control after entering 10 consecutive wrong codes

Compatible with PROKEY ID cards and TAGKEY ID key fobs

1 relay output (NO, C, NC) for door, with input for remote activation

Programmable activation time (1 to 99 seconds) and output mode (pulse or steady)

Tamper alarm

12 or 18V d.c. power supply.

**PROKEY ID**

20710008

125KHz user card

**TAGKEY ID**

20710007

125KHz user key fob

MOUNTING KITS NEXA ALUMINIUM PANEL

● **N6001/AL** 11880601
 Mounting frame for 1 height panels
 Including headers, bracket and side profiles

● **N6011/AL** 11880611
 Horizontal mounting kit for 1 height panels
 Including headers, bracket and linking profile

● **N6002/AL** 11880602
 Mounting frame for 2 heights panels
 Including headers, bracket and side profiles

● **N6012/AL** 11880612
 Horizontal mounting kit for 2 heights panels
 Including headers, bracket and linking profile

● **N6003/AL** 11880603
 Mounting frame for 3 heights panels
 Including headers, bracket and side profiles

● **N6013/AL** 11880613
 Horizontal mounting kit for 3 heights panels
 Including headers, bracket and linking profile

● **N6004/AL** 11880604
 Mounting frame for 4 heights panels
 Including headers, bracket and side profiles

● **N6014/AL** 11880614
 Horizontal mounting kit for 4 heights panels
 Including headers, bracket and linking profile



MOUNTING FRAMES FOR NEXA INOX PANEL

■ **NX6001** 11776001C
 Mounting frame for 1 height panels
 134(W) x 150(H) mm

■ **NX6003** 11776003C
 Mounting frame for 3 heights panels
 134(W) x 384(H) mm

■ **NX6002** 11776002C
 Mounting frame for 2 heights panels
 134(W) x 267(H) mm

■ **NX6004** 11776004C
 Mounting frame for 4 heights panels
 134(W) x 506(H) mm



EMBEDDING BOXES FOR NEXA ALUMINIUM PANEL

● **NCEV-90CS** 11880902A

Embedding box for 1 height panels
99(W) x 133(H) x 56(W) x 56(D) mm

● **NCEV-90C** 11880900

Embedding box for 2 heights panels
99(W) x 238(H) x 56(D) mm

● **CEV-90** 11259906

Embedding box for 3 heights panels
99(W) x 328(H) x 56(D) mm

● **CE-4M** 11797890

Embedding box for 4 heights panels
Non-linkable horizontally
100(W) x 445(H) x 56(D) mm

● **CE-8M** 11797892

Embedding box for 2 panels of 4 heights
Non-linkable horizontally
200(W) x 445(H) x 56(D) mm

EMBEDDING BOXES FOR NEXA INOX PANEL

■ **CE610** 11280610

Embedding box for 1 height panels
125(W) x 140(H) x 56(D) mm

■ **CE620** 11280620

Embedding box for 2 heights panels
125(W) x 257(H) x 56(D) mm

■ **CE630** 11280630

Embedding box for 3 heights panels
125(W) x 374(H) x 56(D) mm

■ **CE640** 11280640

Embedding box for 4 heights panels
Non-linkable horizontally
135(W) x 487(H) x 52(D) mm



ACCESSORIES EMBEDDING BOXES

**UC** 11259990

Pack of 3 cable tunnels
For linking embedding boxes from 1 to 3 heights

**RAP-610A** 11895610

55cm link cable
For connecting EL610A modules of different mounting frames

**RAP-610D** 11895710

27cm link cable
For connecting EL610D and EL606D modules of different embedding boxes

**RAP-610D 100CM** 11895720

100cm link cable
For connecting EL610D and EL606D modules of different embedding boxes

**RAP-100C** 11895810

100cm link cable
For connecting EL632 or EL642 modules with coded panel modules of different embedding boxes

NEXA ALUMINIUM PANEL RAINSHIELDS

● **N711/AL** 11880711
 Rainshield for 1 height panels
 134(W) x 156(H) mm

● **N722/AL** 11880722
 Rainshield for 2 panels of 2 heights
 234(W) x 259(H) mm

● **N721/AL** 11880721
 Rainshield for 2 panels of 2 heights
 134(W) x 259(H) mm

● **N732/AL** 11880732
 Rainshield for 2 panels of 3 heights
 234(W) x 361(H) mm

● **N731/AL** 11880731
 Rainshield for 3 heights panels
 134(W) x 361(H) mm

● **N723/AL** 11880723
 Rainshield for 3 panels of 2 heights
 334(W) x 259(H) mm

● **N741/AL** 11880741
 Rainshield for 4 heights panels
 134(W) x 464(H) mm

● **N733/AL** 11880733
 Rainshield for 3 panels of 3 heights
 334(W) x 361(H) mm



NEXA INOX PANEL RAINSHIELDS

■ **NX711** 11881711C
 Rainshield for 1 height panels
 138(W) x 152(H) mm

■ **NX722** 11881722C
 Rainshield for 2 panels of 2 heights
 272(W) x 269(H) mm

■ **NX721** 11881721C
 Rainshield for 2 panels of 2 heights
 138(W) x 269(H) mm

■ **NX732** 11881732C
 Rainshield for 2 panels of 3 heights
 272(W) x 386(H) mm

■ **NX731** 11881731C
 Rainshield for 3 heights panels
 138(W) x 386(H) mm

■ **NX733** 11881733C
 Rainshield for 3 panels of 3 heights
 408(W) x 386(H) mm

■ **NX741** 11881741C
 Rainshield for 4 heights panels
 160(W) x 509(H) mm



SURFACE BOX WITH INTEGRATED RAINSHIELD FOR NEXA ALUMINIUM PANEL



- | | | | |
|---|-----------------|--|-----------------|
| <p>● N871/AL</p> <p>Surface box with integrated rainshield
For 1 height panels
134(W) x 156(H) x 58(D) mm</p> <hr/> | <p>11880871</p> | <p>● N8741/AL</p> <p>Surface box with integrated rainshield
For 4 heights panels
134(W) x 464(H) x 58(D) mm</p> <hr/> | <p>11880875</p> |
| <p>● N872/AL</p> <p>Surface box with integrated rainshield
For 2 heights panels
134(W) x 259(H) x 58(D) mm</p> <hr/> | <p>11880872</p> | <p>● N874/AL</p> <p>Surface box with integrated rainshield
For 2 panels of 2 heights
234(W) x 259(H) x 58(D) mm</p> <hr/> | <p>11880874</p> |
| <p>● N873/AL</p> <p>Surface box with integrated rainshield
For 3 heights panels
134(W) x 361(H) x 58(D) mm</p> <hr/> | <p>11880873</p> | <p>● N876/AL</p> <p>Surface box with integrated rainshield
For 2 panels of 3 heights
234(W) x 361(H) x 58(D) mm</p> <hr/> | <p>11880876</p> |

SURFACE BOX WITH INTEGRATED RAINSHIELD FOR NEXA INOX PANEL



- | | | | |
|---|------------------|--|------------------|
| <p>■ NX871</p> <p>Surface box with integrated rainshield
For 1 height panels
138(W) x 154(H) x 58(D) mm</p> <hr/> | <p>11881871C</p> | <p>■ NX8741</p> <p>Surface box with integrated rainshield
For 4 heights panels
160(W) x 551(H) x 58(D) mm</p> <hr/> | <p>11881875C</p> |
| <p>■ NX872</p> <p>Surface box with integrated rainshield
For 2 heights panels
138(W) x 271(H) x 58(D) mm</p> <hr/> | <p>11881872C</p> | <p>■ NX874</p> <p>Surface box with integrated rainshield
For 2 panels of 2 heights
272(W) x 271(H) x 58(D) mm</p> <hr/> | <p>11881874C</p> |
| <p>■ NX873</p> <p>Surface box with integrated rainshield
For 3 heights panels
138(W) x 388(H) x 58(D) mm</p> <hr/> | <p>11881873C</p> | <p>■ NX876</p> <p>Surface box with integrated rainshield
For 2 panels of 3 heights
272(W) x 388(H) x 58(D) mm</p> <hr/> | <p>11881876C</p> |

NEXA PANEL



SURFACE ANGLE BOXES FOR NEXA ALUMINIUM PANELS



N911/AL	11280912	N921/AL	11280913	N931/AL	11280914
45° angle surface box For 1 height panels 128(W) x 152(H) x 140(D) mm		45° angle surface box For 2 heights panels 128(W) x 254(H) x 140(D) mm		45° angle surface box For 3 heights panels 128(W) x 357(H) x 140(D) mm	

REPLACEMENT FRAMES FOR NEXA ALUMINIUM PANELS

N611/AL	11880620	N641/AL	11890641	N633/AL-C	11890636
Replacement frame For 1 height panels 200(W) x 278(H) mm		Replacement frame For 4 heights panels 200(W) x 532(H) mm		Replacement frame For 3 panels of 3 heights 350(W) x 430(H) mm	
N611/AL-C	11880624	N622/AL	11880622	N611/911	11880001
Replacement frame For 1 height panels 150(W) x 230(H) mm		Replacement frame For 2 panels of 2 heights 334(W) x 430(H) mm		Stadio panel replacement frame For 1 height panels 134(W) x 153(H) mm	
N621/AL	11880621	N622/AL-C	11880625	N621/921	11880002
Replacement frame For 2 heights panels 200(W) x 430(H) mm		Replacement frame For 2 panels of 2 heights 250(W) x 330(H) mm		Stadio panel replacement frame For 2 heights panels 134(W) x 267(H) mm	
N621/AL-C	11880623	N632/AL	11890632	N631/931	11880003
Replacement frame For 2 heights panels 150(W) x 330(H) mm		Replacement frame For 2 panels of 3 heights 334(W) x 512(H) mm		Stadio panel replacement frame For 3 heights panels 134(W) x 384(H) mm	
N631/AL	11890631	N632/AL-C	11890634	N621/ROCK	11792079
Replacement frame For 3 heights panels 200(W) x 512(H) mm		Replacement frame For 2 panels of 3 heights 250(W) x 430(H) mm		Rock panel replacement frame For 2 heights panels 145(W) x 278(H) mm	
N631/AL-C	11890633	N633/AL	11890635		
Replacement frame For 3 heights panels 150(W) x 430(H) mm		Replacement frame For 3 panels of 3 heights 400(W) x 550(H) mm			

Nexa | 615 replacement



Stadio Compact Series



Nexa 615: 128(W) x 240(H) mm

Replacement of Golmar Stadio Compact Series panels using existing embedding box

- ▶ Select a panel according to the number of push-buttons of the existing panel
- ▶ Add an EL606D electronic push-button module, an N615/AL replacement frame and an N6005/AL mounting kit
- ▶ If you are going to maintain the indoor units, select an audio or video module according to the existing technology. You will find them in the spare parts chapter (page 153)
- ▶ If you are only going to use the embedding box and wiring, add an audio or video module with 2-wire non-polarised "G2+" technology (page 76)

NEXA 615 PANEL

N1130/AL	11881130	3 push-buttons panel
N1140/AL	11881140	4 push-buttons panel
N1260/AL	11881260	6 push-buttons panel
N1280/AL	11881280	8 push-buttons panel

ACCESSORIES

N615/AL	11880615	Replacement frame
N6005/AL	11880605	Mounting kit



Nexa | CUSTOM

Custom panels

Because your building is unique, at Golmar we offer you the possibility of making customized panels. Based on the information you provide us, our design department will make you a personalized panel proposal.

Tailor-made

We adapt the design to the available space, using the existing embedding box or creating a new one. If the facade of your building does not have space, we can supply the panel mounted on a column.



High quality materials

We manufacture our panels in AISI 316 stainless steel, anodised aluminium, brass,... which guarantee their durability.

The push-buttons, always made of stainless steel, have an IP67 protection rating.



◀ Labeling

The label holders are illuminated and the name can be changed without opening the panel. If you prefer, we can engrave laser engraving on the panel, with paint filling, or on metal or acrylic panels.

Full colour ▶

Stainless steel or aluminium panels can be painted in any RAL colour.



NEW

artis

panel for door frames



- ▶ **Technology** "G2+" technology with two non-polarised wires.
- ▶ **Waterproof panel (IP54)** made of 2 mm thick anodised aluminium in natural colour.
- ▶ Flush mounting in door frames with a width of 67,5mm or more (uses the door frame as an embedding box).
- ▶ **2Mpx HD camera with 120° wide angle lens** and white LEDs of variable intensity depending on the exterior lighting conditions.
- ▶ **Voice prompt messages** of the different system status facilitate access to users with visual or hearing impairments.
- ▶ **Relay** with input for remote activation.



ARTIS/1/G2+ 12221110

1 push-button panel
60(W) x 200(H) x 35(D) mm



ARTIS/2/G2+ 12221120

2 push-buttons panel
60(W) x 250(H) x 35(D) mm



ARTIS/3/G2+ 12221130

3 push-buttons panel
60(W) x 300(H) x 35(D) mm



ARTIS/4/G2+ 12221140

4 push-buttons panel
60(W) x 345(H) x 35(D) mm



ARTIS/5/G2+ 12221150

5 push-buttons panel
60(W) x 400(H) x 35(D) mm





indoor units

VIDEO **94**

Summary table 94

N Edge <DB>

Art 102

CE-Art 7 104

AUDIO **96**

Summary table 96































Art 1 106

T-Art 107

N T-520 108

T-500 109

ACCESSORIES **110**

INDOOR UNIT	REFERENCE	CODE	INSTALLATION	PAGE	SCREEN SIZE	CONVERSATION	BLACK COLOUR	MONITORS ADDITIONAL (1)
	ART 4/G2+	12210430		103	4,3"	HANDS-FREE		+3
	ART 4 XLITE/G2+	12210436		103	4,3"	HANDS-FREE		+3
	ART 4H XLITE/G2+	12210432		103	4,3"	HANDS-FREE		+3
	ART 4W LITE/G2+	12210445		103	4,3"	HANDS-FREE		+3
	ART 4WH/G2+	12210437		103	4,3"	HANDS-FREE		+3
	ART 4B LITE/G2+	12210435B		103	4,3"	HANDS-FREE		+3
	ART 4TH LITE/G2+	12210400		103	4,3"	HANDSET/ HANDS-FREE		+3
	ART 7H/G2+	12210702		103	7"	HANDS-FREE		+3
	ART 7W/G2+	12210710		103	7"	HANDS-FREE		+3
	ART 7 LITE/G2+	12210705		103	7"	HANDS-FREE		+3
	ART 7B LITE/G2+	12210705B		103	7"	HANDS-FREE		+3
	EDGE 7/G+	12310751		101	7"	HANDS-FREE		+5
	EDGE 7/IO/G+	12310752		101	7"	HANDS-FREE		+5
	EDGE 7W/G+	12310753		101	7"	HANDS-FREE		+5
	EDGE 7WB/G+	12310753B		101	7"	HANDS-FREE		+5
	EDGE 7AW/G+ 	12310754		101	7"	HANDS-FREE		+5
	ART 4TH/G+	12310400		103	4,3"	HANDSET/ HANDS-FREE		+5
	CE-ART 7W/G2+	12279704		105	7"	HANDSET/ HANDS-FREE		+3
	CE-ART 7/G2+	12279707		105	7"	HANDSET/ HANDS-FREE		+3
	CE-ART 7/G+	12379703		105	7"	HANDSET/ HANDS-FREE		+8

Wi-Fi monitors allow call forwarding to the smartphone via the G2Call+ app

INTERCOM	WI-FI	IMAGE MEMORY	LOOP INDUCTIVE	ALEXA AND GOOGLE HOME	 ANDROID	2 ND DOOR ACTIVATION	DEVICE ACTIVATION	CONNECTION TO CALL REPEATER	"DO NOT DISTURB" FUNCTION	AUTOMATIC DOOR OPENING	DIMENSIONS WITH MOUNTING BRACKET (W x H x D)
●		INTERNAL				●	SAR-G2+	SAV-12	●	●	110 x 155 x 23 mm
●						●	SAR-G2+	SAV-12	●	●	110 x 155 x 23 mm
●			●			●	SAR-G2+	SAV-12	●	●	110 x 155 x 23 mm
●	●	CLOUD		●		●	SAR-G2+	SAV-12	●	●	110 x 155 x 23 mm
●	●	INTERNAL/ CLOUD	●	●		●	SAR-G2+	SAV-12	●	●	110 x 155 x 23 mm
●						●	SAR-G2+	SAV-12	●	●	110 x 155 x 23 mm
●			●			●	SAR-G2+	SAV-12	●	●	153 x 155 x 40 mm
●		INTERNAL	●			●	SAR-G2+	SAV-12	●	●	220 x 155 x 23 mm
●	●	INTERNAL				●	SAR-G2+	SAV-12	●	●	220 x 155 x 23 mm
●						●	SAR-G2+	SAV-12	●	●	220 x 155 x 23 mm
●						●	SAR-G2+	SAV-12	●	●	220 x 155 x 23 mm
●		INTERNAL		●		●	SAR-G+	SAV-12	●	●	179 x 116 x 21 mm
●		INTERNAL		●		●	SAR-G+	SAV-12	●	●	179 x 116 x 21 mm
●	●	INTERNAL/ CLOUD		●		●	SAR-G+	SAV-12	●	●	179 x 116 x 21 mm
●	●	INTERNAL/ CLOUD		●		●	SAR-G+	SAV-12	●	●	179 x 116 x 21 mm
●	●	INTERNAL/ CLOUD		●	●	●	SAR-G+	SAV-12	●	●	179 x 116 x 21 mm
●		INTERNAL	●			●	SAR-G+	SAV-12	●	●	153 x 155 x 40 mm
●	●	INTERNAL				●	SAR-G2+	SAV-12	●	●	262 x 155 x 38 mm
●		INTERNAL				●	SAR-G2+	SAV-12	●	●	262 x 155 x 38 mm
●		INTERNAL				●	SAR-G+	SAV-12	●	●	262 x 155 x 38 mm

(1) Without additional power supply. Consult

INDOOR UNIT	REFERENCE	CODE	INSTALLATION	PAGE	CONVERSATION
	ART 1/G+	12310140	iPG+	106	HANDS-FREE
	ART 1/G2+	12210140	G2+	106	HANDS-FREE
	T-ART/G2+	12210100	G2+	107	HANDSET
	T-ART LITE/G2+	12210101	G2+	107	HANDSET
	T-520/G2+	12210120	G2+	108	HANDSET
	T-520 LITE/G2+	12210121	G2+	108	HANDSET
	T-500	11205500P	4+N	109	HANDSET
	T-510R	11205510P	4+N	109	HANDSET



	ADDITIONAL PHONES(1)	VOLUME REGULATOR	2 nd DOOR ACTIVATION	DEVICE ACTIVATION	CONNECTION TO REPEATER CALL REPEATER	"DO NOT DISTURB" FUNCTION	AUTOMATIC DOOR OPENING	DIMENSIONS WITH MOUNTING BRACKET (W x H x D)
	+3	●	●	SAR-G+	SAV-12	●	●	90 x 138 x 23 mm
	+3	●	●	SAR-G2+	SAV-12	●	●	90 x 138 x 23 mm
	+3	●	●	SAR-G2+	SAV-12	●	●	86 x 154 x 38 mm
	+3	●		SAR-G2+	SAV-12	●		86 x 154 x 38 mm
	+3	●	●	SAR-G2+	SAV-12	●	●	86 x 220 x 45 mm
	+3	●		SAR-G2+	SAV-12	●		86 x 220 x 45 mm
	+2				S-8			86 x 220 x 56 mm
	+2				S-4 or S-8			86 x 220 x 56 mm

(1) Without additional power supply. Consult

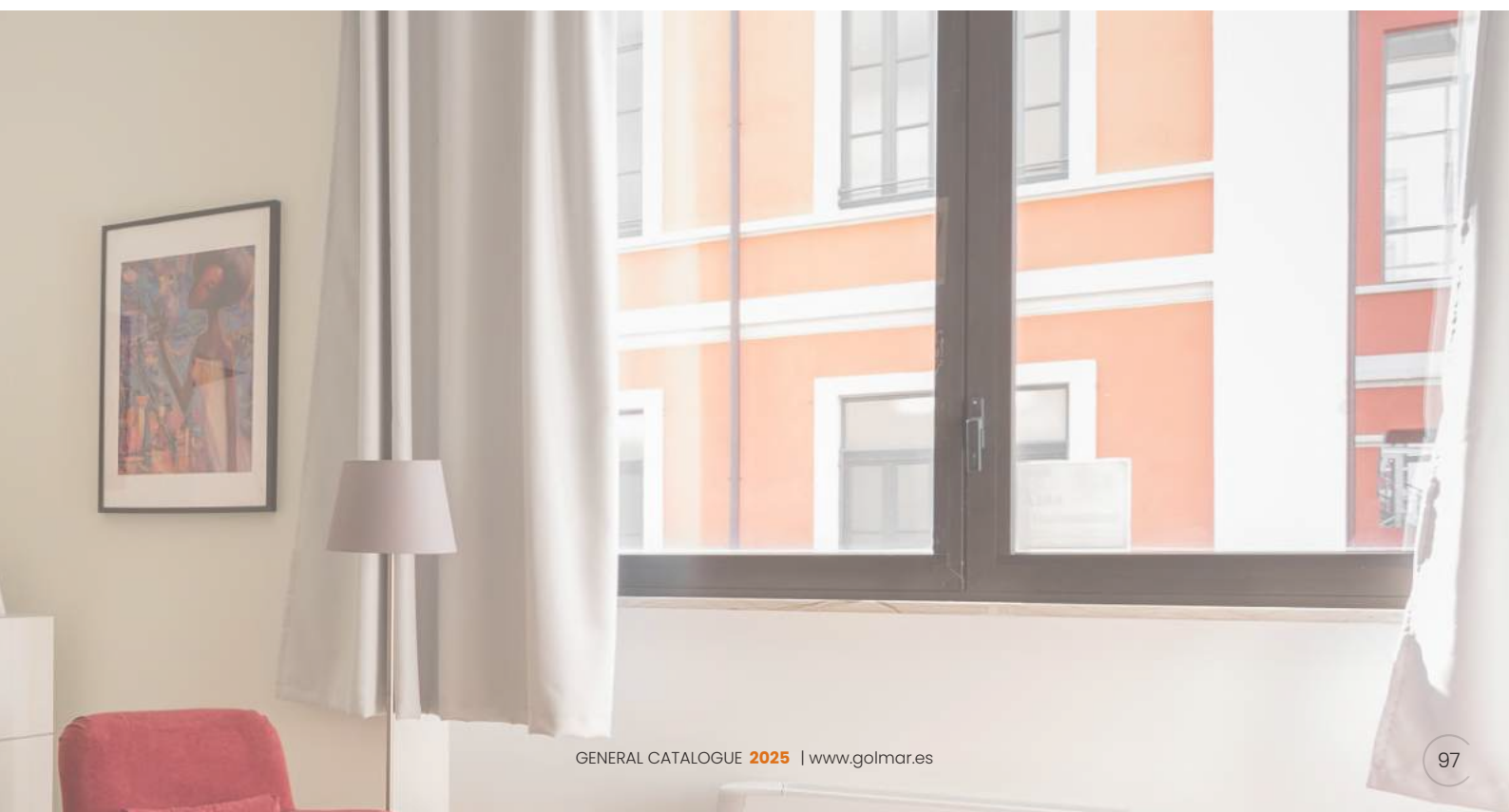

NEW



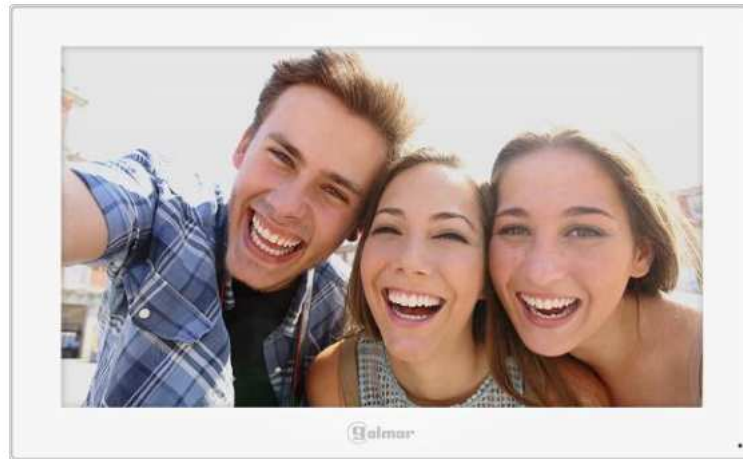

edge





finishes



- ▶ "iPG+" digital installation with TCP/IP protocol
 - ▶ Compatible with GPON networks, SIP and ONVIF protocols, allowing integration in FTTH type networks, with IP cameras and VoIP devices
 - ▶ Housing made of polished ABS plastic, available in black or white colours
 - ▶ Tempered glass front
 - ▶ 7" IPS touch screen with high resolution 1024 x 600 px in 16:9 aspect ratio
 - ▶ Customisable user interface and wallpaper, available in 16 languages
 - ▶ Hands-free communication with high-efficiency hidden speaker
 - ▶ Selectable ring tones and programmable do not disturb function with light indication
 - ▶ Preview of all panels and IP cameras in the system
 - ▶ Selectable opening of up to two doors per panel
 - ▶ Activation of auxiliary devices, such as staircase light (requires the use of an external relay unit)
 - ▶ Programmable automatic door opening function on call reception
 - ▶ Input for door bell call button and output for auxiliary sounder
 - ▶ Communication with other units in the same apartment, building and concierge units
 - ▶ Event log and image capture of unanswered calls with voicemail function
 - ▶ Internal memory for recording up to 100 images and video on microSD card (not included), with automatic deletion after 30 days
 - ▶ Short text messaging service between system monitors
 - ▶ 8 alarm inputs and 2 programmable relay outputs (except IO and A models)
 - ▶ Up to 6 units within the same home
 - ▶ 48V PoE power supply, connection via RJ45 connector, with the possibility of local power supply at 12Vdc.
 - ▶ Wall installation by means of RC-EDGE mounting bracket (not included) adaptable to universal box
 - ▶ Dimensions with socket connector: 179(W) x 116(H) x 21(D) mm
- Optional:
-  Integrated Wi-Fi module (**W models**) to forward calls to the cell phone, by using the G2Call+ app
 -  Compatibility with Alexa and Google Home devices (**W models**)
 -  Cloud image memory (**W models**)
 -  Version with Android™ 12 operating system and two independent network cards (**A models**) allowing installation of apps and control of other devices
 -  RJ45 input and output connectors (**IO models**) for daisy-chain installation up to 20 monitors

2
finishes
black and white

**Tempered
glass**
high resistance

7"
1024 x 600 px
HD image
IPS screen

13mm
depth

All the control in your hands.

The Edge monitor allows on-screen functions to be customised to the needs of each user, facilitating usability and enhancing the experience. Thanks to the Android version, which also has two independent networks, the most demanding users will be able to access the control applications of other systems in the home.

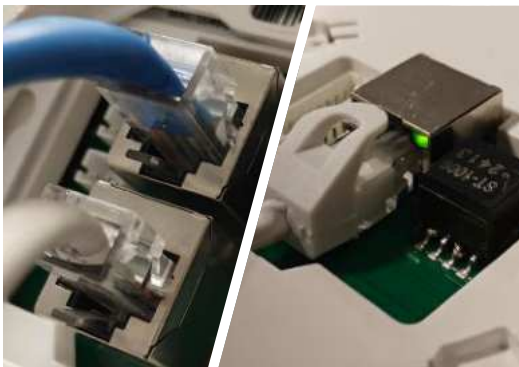

Easier connections.

If the installation requires it, Edge is the only IP monitor on the market that incorporates an input and output connector for connecting up to 20 units in daisy-chain. The basic version uses a 90° connector, which makes it possible to dispense with a box in exposed cable installations.

Secure mounting.

With a simple twist, the Edge monitor is securely attached to the mounting bracket, preventing accidental drops when the monitor is unintentionally knocked from the sides or bottom.





EDGE 7/G+ 12310751

7" hands-free monitor
90° RJ45 connector
Alarm inputs
Requires RC-EDGE mounting bracket



EDGE 7/IO/G+ 12310752

7" hands-free monitor
Two RJ45 connectors (input and output)
Requires RC-EDGE mounting bracket



EDGE 7W/G+ 12310753
EDGE 7WB/G+ 12310753B

7" hands-free monitor
Wi-Fi call forwarding
90° RJ45 connector
Alarm inputs
Requires RC-EDGE mounting bracket



EDGE 7AW/G+ 12310754

7" hands-free monitor
Android™ OS
Wi-Fi call forwarding
Two RJ45 connectors (independent networks)
Requires RC-EDGE mounting bracket



RC-EDGE 12390751

Mounting bracket
White colour

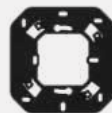

RC-EDGE/B 12390751B



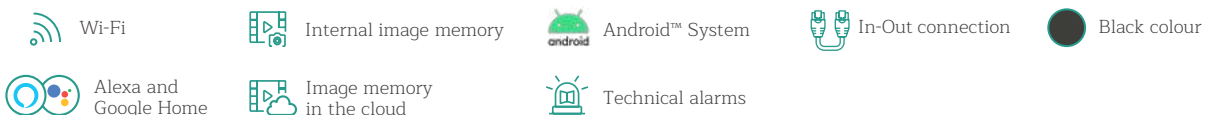

Mounting bracket
Black colour

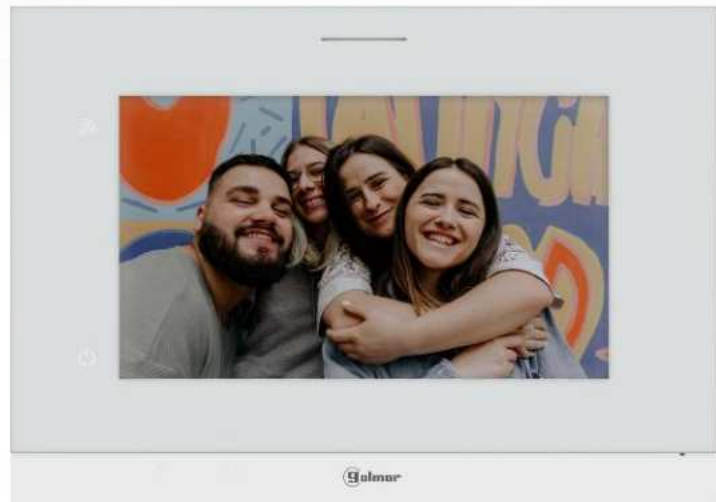

Art^I monitors

finishes



- ▶ Housing made of polished ABS plastic, available in black or white colours
 - ▶ Acrylic front with 4.3" or 7" widescreen display in 16:9 format
 - ▶ Home code programming via dip switches (only units with "G2+" technology)
 - ▶ Capacitive and illuminated push-buttons, with acoustic push confirmation
 - ▶ Touch screen on ART 7W/G2+ model
 - ▶ Hands-free or dual communication (on monitors with handset)
 - ▶ Selectable ring tones and do not disturb function with light indication
 - ▶ Preview of system panels
 - ▶ Selectable opening of up to two doors per panel
 - ▶ Activation of auxiliary devices, such as staircase light (requires the use of an external relay unit)
 - ▶ Automatic door opening function on call reception
 - ▶ Input for door bell button and output for auxiliary sounder
 - ▶ Intercommunication with other units in the same apartment, the building and the concierge
 - ▶ Integration with IP cameras installed in the common areas (requires DQ-IPCAM-G2+ in case of "G2+" technology systems)
 - ▶ Up to 4 units within the same apartment (6 in systems with "IPG+" technology)
 - ▶ Wall installation by means of mounting bracket (included) adaptable to universal box
 - ▶ Dimensions with mounting bracket:
 - ART 4: 110(W) x 155(H) x 23(D) mm.
 - ART 4T: 153(W) x 155(H) x 40(D) mm. (handset included)
 - ART 7: 220(W) x 155(H) x 23(D) mm.
- Optional:
-  Integrated Wi-Fi module to forward calls to the smartphone, by using the G2Call+ app
 -  Compatibility with Alexa and Google Home devices
 -  Internal memory for recording up to 100 images and video on microSD card (not included), with automatic deletion after 30 days
 -  Cloud image memory
 -  Inductive amplifier for hearing aids

ART 4



ART 4 XLITE/G2+ 12210436

ART 4B LITE/G2+ 12210435B

4.3" hands-free monitor



ART 4/G2+ 12210430

4.3" hands-free monitor
Internal image memory



ART 4H XLITE/G2+ 12210432

4.3" hands-free monitor
Inductive loop amplifier



ART 4WH/G2+ 12210437

4.3" hands-free monitor
Internal image memory
Wi-Fi call forwarding and cloud memory
Alexa and Google Home compatible
Inductive loop amplifier



ART 4W LITE/G2+ 12210445

4.3" hands-free monitor
Wi-Fi call forwarding and cloud memory
Alexa and Google Home compatible



ART 4TH/G2+ 12210400

4.3" monitor with handset
Internal image memory
Inductive loop amplifier
48V PoE switch support
Connection via RJ45 connector



ART 4TH LITE/G2+ 12210400

4.3" monitor with handset
Inductive loop amplifier



ART 7



ART 7 LITE/G2+ 12210705

ART 7B LITE/G2+ 12210705B

7" hands-free monitor



ART 7W/G2+ 12210710

7" hands-free monitor
Internal image memory
Wi-Fi call forwarding



If there is more than one ART 7W/G2+ monitor, an additional FA-ART 7W (12240170) power supply is required



ART 7H/G2+ 12210702

7" hands-free monitor
Internal image memory
Inductive loop amplifier



CE-Art 7 | guard units

- ▶ Housing made of polished ABS plastic in white colour
- ▶ Acrylic front panel with 7" widescreen display in 16:9 format
- ▶ Touch screen with acoustic touch confirmation
- ▶ Private communication with handset or hands-free
- ▶ Handset with inductive amplifier for hearing aids
- ▶ Preview of system panels
- ▶ Selectable opening of up to two doors per panel
- ▶ Activation of auxiliary devices, such as staircase light
- ▶ Selectable ring tones and do not disturb function with light indication
- ▶ Automatic door opening function
- ▶ Input for door bell button and output for auxiliary sounder
- ▶ Intercommunication with other units in the building and other concierges via dialling code or selection from the agenda
- ▶ Virtual call keypad, which avoids the inconvenients of traditional keypads
- ▶ Event log, showing calls not attended by the guard unit
- ▶ Internal memory for recording up to 100 images and video on microSD card (not included), with automatic deletion after 30 days
- ▶ Call forwarding to another home in the concierge's absence
- ▶ Panel's call capture and day-night function
- ▶ Electronic lock to prevent unauthorized personnel from using the guard unit
- ▶ Integration with IP cameras installed in common areas (requires DQ-IPCAM-G2+ in case of systems with "G2+" technology)
- ▶ Up to 4 general guard units and 4 per building in "G2+" technology installations
- ▶ Up to 19 general guard units and 9 per building in installations with "IPG+" technology
- ▶ Wall installation by means of wall mounting bracket (included) adaptable to universal box
- ▶ Dimensions with terminal connector: 262(W) x 155(H) x 38(D) mm (including handset).

In guard units with "IPG+" technology:

- ▶ Integrated camera for video communication with indoor units
- ▶ Short text messaging and broadcasting service for emergencies
- ▶ Notification of alarms occurring in the apartments

Optionally in guard units with "G2+" technology:

- ▶ Integrated Wi-Fi module for call forwarding to smartphones via free G2Call+ app

2-wire non-polarised installation

G2+

Installation with TCP/IP protocol

iPG+



CE-ART 7/G2+

12279707

- 7" guard unit
- Internal image memory
- Inductive loop amplifier



CE-ART 7W/G2+

12279704

- 7" guard unit
- Internal image memory
- Wi-Fi call forwarding
- Inductive loop amplifier



CE-ART 7/G+

12379703

- 7" guard unit
- Internal image memory
- Inductive loop amplifier
- 48V PoE switch support
- Connection via RJ45 connector

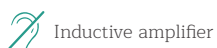

Art 1

Hands-free indoor unit

- ▶ Housing made of polished ABS plastic in white colour
- ▶ Acrylic front panel
- ▶ Call address programming via micro-switch (only "G2+" technology)
- ▶ Capacitive and illuminated push-buttons, with acoustic push confirmation
- ▶ Full duplex hands-free audio communication
- ▶ Selectable opening of up to two doors per panel
- ▶ Activation of auxiliary devices, such as staircase light (requires the use of an external relay unit)
- ▶ Selectable ring tones and programmable do not disturb function with light indication
- ▶ Automatic door-opening function on call reception
- ▶ Selectable auto-answer function ("IPG+" technology only)
- ▶ Input for door bell button and output for auxiliary sounder
- ▶ Call to guard unit
- ▶ Intercommunication with other units in the same apartment
- ▶ Up to 4 units within the same apartment (6 in systems with "IPG+" technology)
- ▶ Wall installation by means of wall mounting bracket (included) adaptable to universal box
- ▶ Dimensions with terminal connector: 90(W) x 138(H) x 23(D) mm.

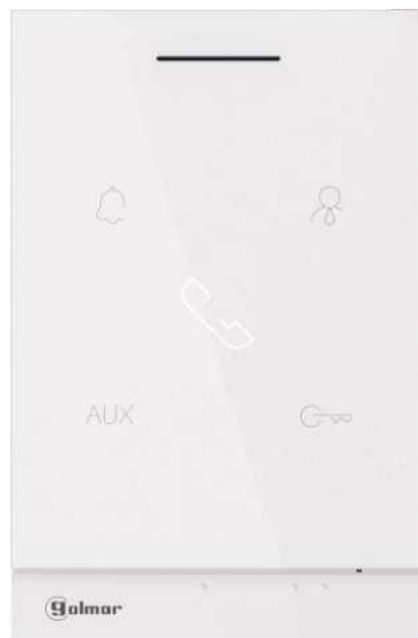

ART 1/G2+

12210140

Hands-free audio unit



ART 1/G+

12310140

Hands-free audio unit
48V PoE switch support
Connection via RJ45 connector

T-Art | Telephone



- ▶ Housing made of polished ABS plastic in white colour
- ▶ Programming of the house code by means of a micro-switch
- ▶ Capacitive push-buttons with acoustic push confirmation
- ▶ Selectable ring tones and programmable do not disturb function with light indication
- ▶ Automatic door-opening function on call reception
- ▶ Input for door bell button and output for auxiliary sounder
- ▶ Call to guard unit
- ▶ Up to 4 units within the same apartment
- ▶ Wall installation by means of wall mounting bracket (included) adaptable to universal box
- ▶ Dimensions with terminal connector: 86(W) x 154(H) x 38(D) mm (handset included).

Additional features of model T-ART/G2+:

- ▶ Power on and door opening indicator lights
- ▶ Selectable opening of up to two doors per panel
- ▶ Activation of auxiliary devices, such as staircase light (requires the use of an external relay unit)
- ▶ Intercommunication with other units in the same apartment



T-ART/G2+ 12210100
Handset with additional features



T-ART LITE/G2+ 12210101
Handset with basic features

NEW

T-520

Telephone

- ▶ Housing made of polished ABS plastic in white colour
- ▶ Programming of the house code by means of a micro-switch
- ▶ Mechanical push-buttons with acoustic push confirmation
- ▶ Selectable ring tones and do not disturb function with light indication
- ▶ Automatic door-opening function on call reception
- ▶ Input for door bell button and output for auxiliary sounder
- ▶ Call to guard unit
- ▶ Up to 4 units within the same apartment
- ▶ Wall installation
- ▶ Dimensions with terminal connector: 86(W) x 220(H) x 45(D) mm (handset included).

Additional features of model T-520/G2+:

- ▶ Selectable opening of up to two doors per panel
- ▶ Dedicated push-button for calling the concierge
- ▶ Activation of auxiliary devices, such as staircase light (requires the use of an external digital relay unit)
- ▶ Intercommunication with other units in the same apartment



T-520/G2+

12210120

Handset with additional features



T-520 LITE/G2+

12210121

Handset with basic features

T-500

Telephone



- ▶ Housing made of polished ABS plastic in white colour
- ▶ Mechanical door opening push-button
- ▶ Electronic or buzzer call, depending on model
- ▶ Up to 3 units within the same apartment
- ▶ Wall installation
- ▶ Dimensions with terminal connector: 86(W) x 220(H) x 56(D) mm (handset included).

Additional features of model T-510R:

- ▶ Specially designed for replacement of other models
- ▶ Microphone and loudspeaker gain adjustments
- ▶ High sensitivity electret microphone



T-500

11205500P

Electronic call handset



T-510R

11205510P

Universal handset
Buzzer and electronic call
Microphone and loudspeaker gain
adjustments

Accessories

VIDEO DISTRIBUTORS



D2L-G2+ 12258950
 2-output video distributor
 Short-circuit protected outputs
 45(W) x 45(H) x 15(D) mm



D4L-G2+ 12258940A
 4-output video distributor
 45(W) x 45(H) x 15(D) mm



D4L-G2+/DIN 12258940
 4-output video distributor
 For DIN rail installation
 70(W) x 90(H) x 45(D) mm (4DIN)

ETHERNET SWITCHES



DCS-G+/48 12358971
 1-output PoE 48VDC Ethernet switcher.
 Requires DCP-G+/48 injector
 47(W) x 47(H) x 21(D) mm



DCP-G+/48 12358974
 4-output 48VDC PoE 48VDC PoE Injector
 Connection of up to 20 DCS-G+/48 switches
 FA-DC48/G+ power supply required
 70(W) x 90(H) x 30(D) mm (4DIN)

CALL REPEATERS



SAV-12 12480260
 Call repeater
 58(W) x 61(H) x 25(D) mm



S-8 11290080
 Call repeater
 For handsets with electronic call
 82(W) x 82(H) x 42(D) mm



S-4 11290040
 Call repeater
 For handsets with buzzer call
 82(W) x 82(H) x 42(D) mm

DESK-MOUNT SUPPORT











SOB-UNI 12192202
 Metal desk-mount support
 For any indoor unit
 160(W) x 175(H) x 140(D) mm



CABLE SOB-UNI 12192201
 SOB-UNI cradle connection cable
 Including 2 meters CAT5 cable with
 connectors and wall box



ADAPTER FRAMES

	AUDIO			VIDEO			
	T-5XX	T-ART	ART 1	ART 4	ART 4TH	ART 7	EDGE
 MAC-500 11298500 110(W) x 265(H) mm	●						
 MAC-ART 12260100 110(W) x 225(H) mm		●	●	●			
 MAC-M1 12260210 140(W) x 240(H) mm		●	●	●			
 MAC-M2A 12260221 210(W) x 245(H) mm				●			
 MAC-M2-ART 4TH 12260223 230(W) x 230(H) mm					●		
 MAC-M2/ART 12260220A 230(W) x 230(H) mm				●		●	●
 MAC-M2-HOLES 12260222 230(W) x 230(H) mm				●		●	●
 MAC-M3 12260230 260(W) x 260(H) mm				●		●	●
 MAC-M3-HOLES 12260240 260(W) x 260(H) mm				●		●	●





accessories

complete installations

Door openers	114
Power supplies	117
Relay and extension units	118
Cables and insulating gel	119

Door openers

The main characteristics of the door openers are:

- ▷ Housing made of light alloy of 2mm. thickness
- ▷ Adjustable bolt up to 5mm
- ▷ Unlocking function on E models, which allows the door to be opened at any time by simply pushing on it

Three mechanical operating modes:

- ▷ Normal, which allows the door to be opened while holding down the door opening pushbutton. In systems with digital installation, the electric lock release is activated for a period of time with a single push.
- ▷ Normal inverse, the electric lock release is activated when the power supply is disconnected
- ▷ Automatic, which unlocks the electric lock release with a single press and locks again when the door is closed.

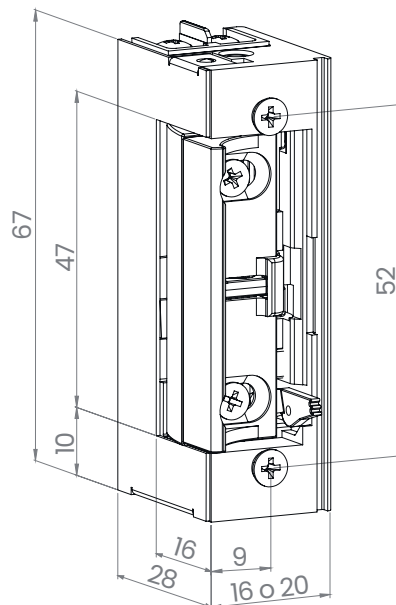

REFERENCE	CODE	WIDTH	VOLTAGE (POWER CONSUMPTION)		OPERATION
			ALTERN CURRENT	DIRECT CURRENT	
CV-14P/UNI/SF	20600155	20mm	12V-24Vac (250-510mA)	12V-24Vdc (300-600mA)	Normal
CV-16P/UNI/SF	20600160	16mm	12V-24Vac (250-510mA)	12V-24Vdc (300-600mA)	Normal
CV-24P/UNI/SF	20600253	20mm	12V-24Vac (250-510mA)	12V-24Vdc (300-600mA)	Automatic
CV-24EP/UNI/SF	20600255	20mm	12V-24Vac (250-510mA)	12V-24Vdc (300-600mA)	Automatic
CV-26P/UNI/SF	20600158	16mm	12V-24Vac (250-510mA)	12V-24Vdc (300-600mA)	Automatic
CV-26EP/UNI/SF	20600159	16mm	12V-24Vac (250-510mA)	12V-24Vdc (300-600mA)	Automatic
CV-34P/DC/SF	20600353	20mm	-	8V-12Vdc (300mA)	Normal Reverse

Shields for 16mm door opener

REFERENCE	CODE	MATERIAL	SIZE
ESCUDO C/16/G	20690053	Gray steel	Short
ESCUDO L/16/G	20690054	Gray steel	Long

Shields for 20mm door opener

REFERENCE	CODE	MATERIAL	SIZE
ESCUDO C/G	20690051	Gray steel	Short
ESCUDO M/G	20690055	Gray steel	Medium
ESCUDO L/G	20690052	Gray steel	Long
ESCUDO M/INOX	20690910	Stainless steel	Medium
ESCUDO L/INOX	20690911	Stainless steel	Long
ESCUDO SU/G	20690061	Gray steel	Surface

Detection contacts



7111 20607111

Open door detection contacts
Double contact



7113 20607113

Open door detection contacts
Triple contact

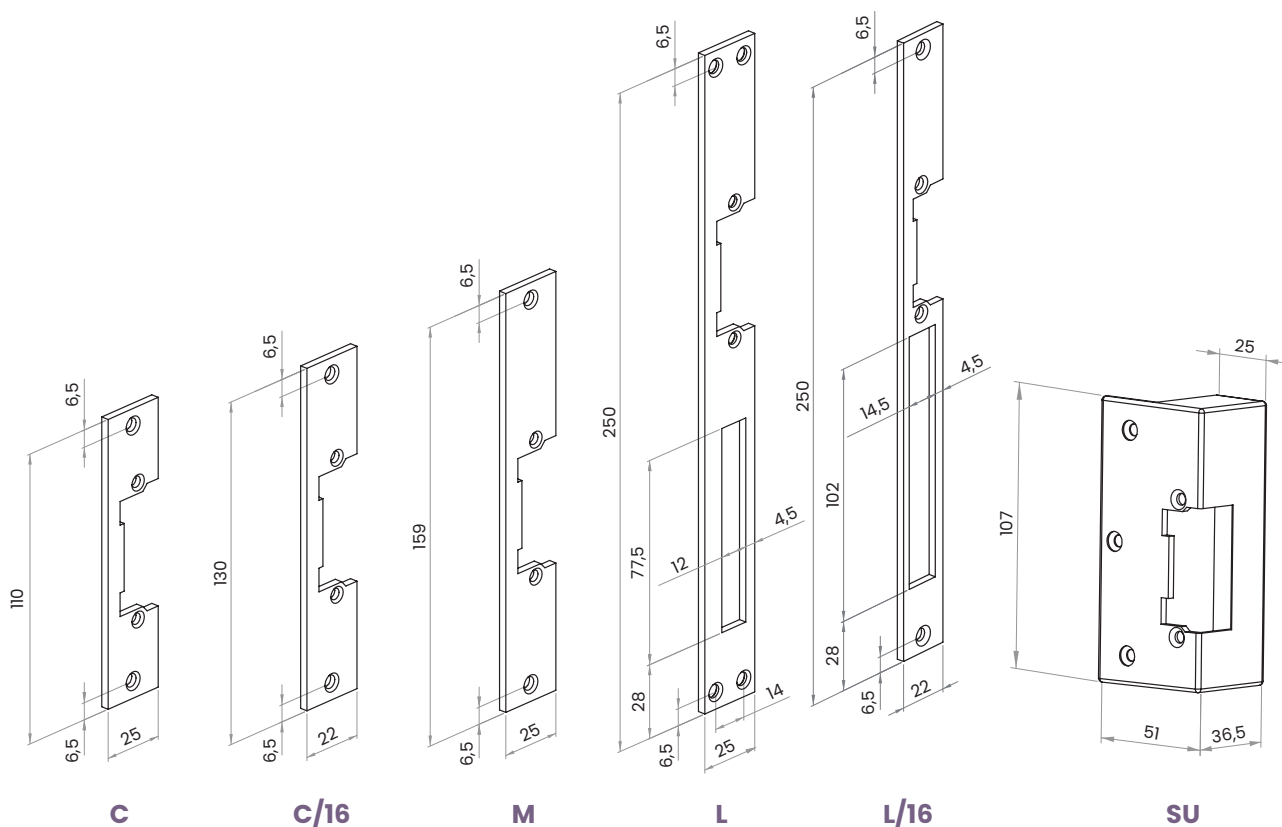

Security

door openers

When the door is closed, a bolt goes through the door frame, preventing it from being forced open, e.g. by using a card. They are certified for emergency exits according to EN 179.

Made of stainless steel and available for 35mm and 50mm doors

REFERENCE	CODE	VOLTAGE (POWER CONSUMPTION)	
		12Vac	12Vdc
CV-14 SEGUR 35	20600250	820mA	1.120mA
CV-14 SEGUR 50	20600251	820mA	1.120mA

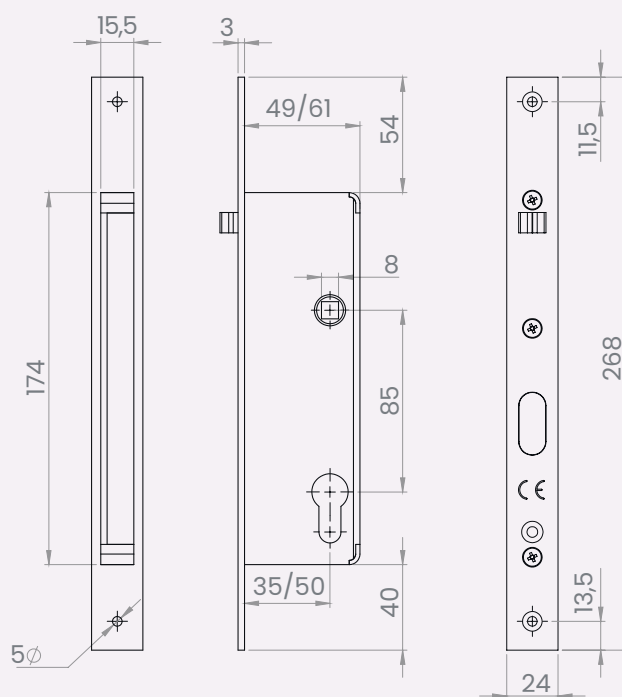

colmar



Power supplies

POWER SUPPLIES



FA-G2+ 12240100

Power supply for G2+ systems
Up to 4 outdoor panels with 32 monitors or 128 audio units
30VDC/1.5A output with 110 and 240VAC power supply.
138(W) x 90(H) x 60(D) mm (8 DIN)



FA-ART 7W 12240170

Power supply
For monitors with more than one ART 7W/G2+ monitor
24VDC/1A output with power supply between 100 and 240VAC.
55(W) x 84(H) x 54(D) mm (3 DIN)



HRF-12/1,25A 10900012

Power supply
For local powering of IPG+ devices
12VDC/1.25A output with power supply between 85 and 264VAC.
18(W) x 90(H) x 60(D) mm (1 DIN)



FA-DC48/G+ 12340105

Power supply
For DCP-G+/48 injector
48VDC/2A output with power supply between 100 and 240VAC.
140(W) x 90(H) x 60(D) mm (8 DIN)

TRANSFORMERS



TF-104 20691040

Transformer
12VAC output with 230VAC / 18VA power supply. / 18VA.
52(W) x 90(H) x 60(D) mm (3 DIN)

48VDC POE SWITCHES



SW-104 31600238

4-port 10/100Mbps PoE switch
2 Uplink 10/100Mbps ports
1.6Gbps bandwidth
80W output power (max. 30W per port)
100 to 240VAC power supply.
190(W) x 32(H) x 130(D) mm



SW-108 31600239

8-Port PoE 10/100Mbps PoE Switch
2 Uplink 10/100Mbps ports
2Gbps bandwidth
150W output power (max. 30W per port)
100 to 240VAC power supply.
210(W) x 32(H) x 140(D) mm



SW-116 31600240

16-port PoE 10/100Mbps PoE switch
2 Uplink 10/100/1000Mbps ports
1 SFP 10/100/1000Mbps port
24Gbps bandwidth
300W output power (max. 30W per port)
100 to 240VAC power supply.
295(W) x 45(H) x 190(D) mm



SW-124 31600241

24-port PoE 10/100Mbps Switch
2 Uplink 10/1000Mbps ports
2 SFP 10/100/1000Mbps ports
20Gbps bandwidth
500W output power (max. 30W per port)
100 to 240VAC power supply.
440(W) x 45(H) x 290(D) mm

Accessories

RELAY UNITS



▼ SAR-G2+ 12258965

Relay unit for G2+ systems
 For activation of external devices connected to the bus (staircase lights, door openers, ...)
 Three-contact output relay
 Input for remote activation push button
 12VDC output.
 Bus power supply
 69(W) x 90(H) x 45(D) mm (4 DIN)



▼ SAR-G+ 12358965

Ethernet relay unit for IPG+ systems
 For activation of external devices connected to the network (staircase lights, door openers, ...)
 Three-contact output relay
 Input for remote activation push button or alarm connection
 12VDC output.
 Power supply PoE 48VDC or local power supply at 12VDC.
 69(W) x 90(H) x 45(D) mm (4 DIN)



SAR-12/24 11291012

Relay unit
 12 to 24VAC or DC input.
 For activation of external devices (staircase lights, door openers, ...)
 Three-contact output relay
 69(W) x 90(H) x 45(D) mm (4 DIN)



▼ LCU-16/G+ 12380616

Lift controller for IPG+ systems
 Up to 16 floors expandable to 96 (using 6 units)
 Wiegand input for external access control
 210(W) x 100(H) x 30(D) mm (12 DIN)

EXPANSION ACCESSORIES



▼ DPM-G2+ 12258955

Switching unit for four door stations
 For G2+ systems
 69(W) x 90(H) x 45(D) mm (4 DIN)



▼ DQ-IPCAM-G2+ 12458990

16 IP camera connection unit
 Control from G2+ monitors (except ART 4 XLite)
 ONVIF protocol
 140(W) x 90(H) x 30(D) mm (8 DIN)



▼ RD-G2+ 12258960

Digital repeater for G2+ systems
 For system expansion in groups of 32 monitors
 For indoor system buildings with general panels
 For increasing the distance between devices
 Requires FA-G2+ power supply
 69(W) x 90(H) x 45(D) mm (4 DIN)

CABLES



RAP-GTWIN/HF

20160031A

Cable for installations with G2+ technology
2 x 1.00 mm conductor²
Outer diameter 6.6 mm
Sales unit: 100 m reel



RAP-GTWIN/HF 500M

20160033A

Cable for installations with G2+ technology
2 x 1.00 mm conductor²
Outer diameter 6.6 mm
Sales unit: 500 m reel



UTP-CAT6

31600300

Cable for installations with IPG+ technology
Outer diameter of 6 mm
Sales unit: 305 m reel



M-8C

20120080

Cable for 4+n installation branches
8 conductors of 0.20mm²
5 mm outer diameter
Sales unit: 100 m reel

INSULATING GEL



SEAL BIT +

20630001

Single component insulating gel
For protection of electrical and electronic components
Special for low temperatures
280 ml cartridge



SEAL BIT 2+

20630002

Two-component insulating gel
For protection of electrical and electronic components
Two 500 ml bottles to be mixed together





access control



Controllers iP-Opener	124
EASYGATE controllers	125
2SAFE devices	126
WIEGAND 26 devices	129
Stand-alone devices	132
Stand-alone radio devices	133
Emitter controls	133
Proximity cards and key fobs	134
Power supplies	135
UHF identification	136
Wireless handles	137
Push buttons and switches	138

iP-Opener

| access control solutions

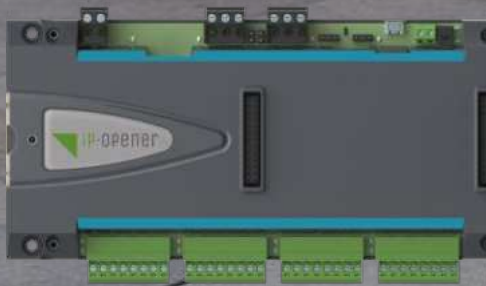
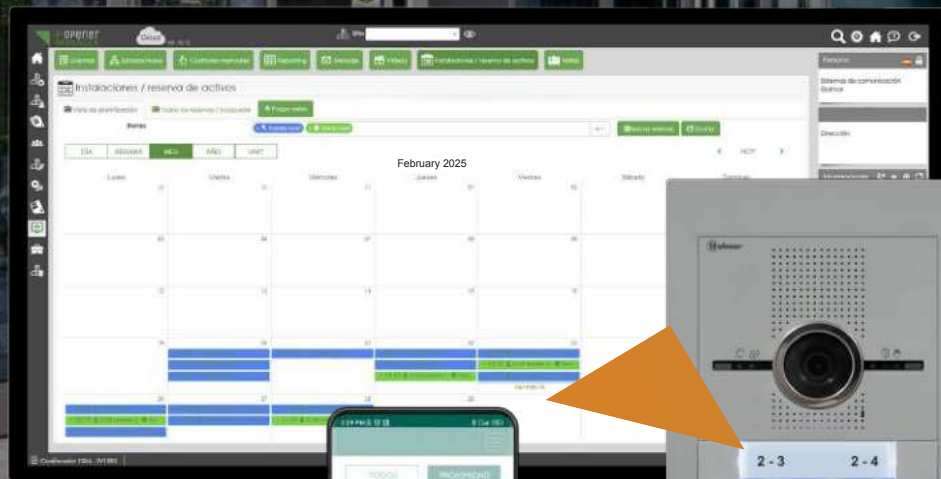

iP-Opener is a scalable system that allows you to create installations of any size. Powerful and modular, it uses the latest encryption technology to allow you to secure your doors with efficiency and simplicity.

iP-Opener is a networked access control solution, which connects to a remote cloud service (www.ip-opener.com), allowing you to manage the site, obtain logs and monitor all events in real time remotely. It is also possible to apply new configurations, add credentials or modify permissions to groups of users as if connected locally on the network. It has a facilities booking service module, which, through the resident's portal, allows the creation of restricted access

areas, depending on occupancy and availability, such as gyms, paddle tennis courts, sports areas... iP-Opener provides numerous functions such as: zone management, reflexes, anti-pass back, among others, that allow programming the logics and routines that the area may require. The powerful management software allows these and more functionalities, which are programmed in a simple and intuitive way.

Residential

iP-Opener fits perfectly into residential projects, from building complexes to BTR (build-to-rent) projects.



Healthcare

The iP-Opener range especially enhances security and access control in the sanitary sector, from assisted living homes, elderly housing, clinics to large hospitals.



Service sector

Secure and manage access in industries, offices, student campuses as well as in the hospitality sector, restaurants and hotels.



IP-OPENER CONTROLLERS

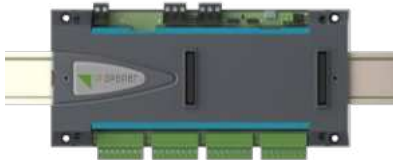

GM-IPOP-1P	20780200
GM-IPOP-2P-WIEG	20730002
GM-IPOP-4P	20780202

Three controller models:

- 1 non-expandable access (1P model) with 2SAFE protocol
- 2 accesses (model 2P-WIEG), expandable to 6, with Wiegand 26 protocol
- 4 accesses (model 4), expandable to 6, with 2SAFE protocol

Remote programming and management through the iP-Opener Manager web environment

Network connection by TCP/IP or RS485

Verification by PIN, RFID, Bluetooth, QR, UHF or RF

Capacity for up to 100,000 users and storage of up to 20,000 events

48VDC/2A output relay(s) (NO, C, NC)

Input(s) for remote activation button(s)

Installation in metal cabinet (not included)

12VDC/1.5A power supply

198(W) x 90(H) x 34(D) mm (11DIN)

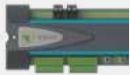

GM-IPOP-EXP2P 20780211
 2 access expansion module
 For GM-IPOP-4P controller
 Plug-in installation on the controller
 198(W) x 70(H) x 26(D) mm (11DIN)



GM-IPOP-EXP4PW 20730001
 4 access expansion module
 For controller GM-IPOP-2P-WIEG
 Plug-in installation on the controller
 198(W) x 70(H) x 26(D) mm (11DIN)



GM-IPOP-EXP12E 20780213
 12-input expansion module
 Plug-in installation on the controller
 198(W) x 70(H) x 26(D) mm (11DIN)



GM-IPOP-EXP12S 20780212
 12-output expansion module
 48VDC/1A or 24VDC/5A output relays (NO, C, NC)
 Plug-in installation on the controller
 198(W) x 70(H) x 26(D) mm (11DIN)

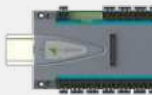

GM-IPOP-10E-RS485 20730007
 10-input expansion module
 Installation via RS485 with the controller
 200(W) x 90(H) x 34(D) mm (11DIN)

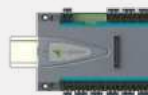

GM-IPOP-10S-RS485 20730004
 10-outputs extension module
 48VDC/1A or 24VDC/5A output relays (NO, C, NC)
 Installation via RS485 with the controller
 200(W) x 90(H) x 34(D) mm (11DIN)

ACCESSORIES FOR IP-OPENER CONTROLLERS

**GM-PSIPOP-S** 20700080

Metal cabinet with lock
Capacity for one controller, one expansion module and one BAT-7A battery
12Vdc/3.5A power supply included
Tamper alarm
200(W) x 230(H) x 82(D) mm

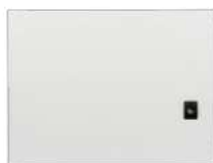
**GM-PSIPOP-M** 20700023

Metal cabinet with lock
Capacity for 2 controllers, 2 expansion modules and one BAT-7A battery
12Vdc/3.5A power supply included
Tamper alarm
456(W) x 342(H) x 100(D) mm

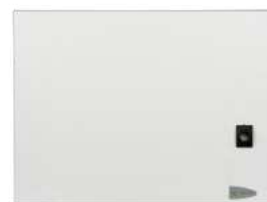
**GM-PSIPOP-G** 20780125

Metal cabinet with lock
Capacity for 4 controllers, 4 expansion modules and one BAT-7A battery
12Vdc/7A power supply included
Tamper alarm
456(W) x 505(H) x 100(D) mm

**RES-IPOP** 20710501

Module for activation of the booking management function

**BAT-7A** 21090070

12Vdc/7Ah rechargeable battery
Maintenance-free lead acid
Weight: 2.700gr
Without lockable metal cabinet
151(W) x 91(H) x 65(D) mm

EASYGATE CONTROLLERS

**EASYGATE** 20740440

Non-expandable 1-access controller with 2SAFE protocol
Only for proximity reader with 2SAFE protocol. BLE feature cannot be used.
Local management via master card or remote management via web environment
No internet connection required for remote management
Capacity for up to 2,000 users
Relay output (NO, C, NC)
12/24VAC or DC power supply.
70(W) x 75(H) x 19(D) mm

**EASYGATE-RF** 20730005

Non-expandable 2-access controller with 2SAFE protocol
Only for proximity reader with 2SAFE protocol. BLE feature cannot be used.
Built-in radio frequency receiver for GM-WEIPOP and GM-WEIPOP MF+ controllers
Local management via master card or remote management via web environment
No internet connection required for remote management
Capacity for up to 2,000 users
Output relays (NO, C, NC)
Inputs for remote activation button
12/24VAC or DC power supply.
120(W) x 100(H) x 45(D) mm

2SAFE DEVICES

**GM-SRIPOP** 20780205

Proximity reader 13,56MHz with 2SAFE protocol
 For iP-Opener and EASYGATE controllers
 Status indicator light
 Indoor wall installation
 78(W) x 78(H) x 18(D) mm
 Compatible with Golmar MIFARE Classic and MIFARE+ cards, key fobs and controllers

**GM-IPOP 40** 20720004

13,56MHz proximity reader and Bluetooth with 2SAFE protocol
 Vandal-proof and waterproof housing
 For iP-Opener and EASYGATE controllers
 Status indicator lights
 Outdoor wall installation
 47(W) x 90(H) x 23(D) mm
 Compatible with Golmar MIFARE Classic and MIFARE+ cards, key fobs and remotes
 Bluetooth activation via K-APP mobile application (requires BLE points)

**GM-MRIPOP** 20780204

Proximity reader 13,56MHz with 2SAFE protocol
 For iP-Opener and EASYGATE controllers
 Status indicator light
 Indoor wall installation
 43(W) x 78(H) x 17(D) mm
 Compatible with Golmar MIFARE Classic and MIFARE+ cards, key fobs and controllers

**GM-IPOP 80** 20720005

13,56MHz proximity reader and Bluetooth with 2SAFE protocol
 Vandal-proof and waterproof housing
 For iP-Opener and EASYGATE controllers
 Status indicator lights
 Outdoor wall installation
 85(W) x 90(H) x 25(D) mm
 Compatible with Golmar MIFARE Classic and MIFARE+ cards, key fobs and controllers
 Bluetooth activation via K-APP mobile application (requires BLE points)

**GM-ORIPOP** 20780214

Proximity reader 13,56MHz with 2SAFE protocol
 For iP-Opener and EASYGATE controllers
 Status indicator light
 Outdoor wall installation
 45(W) x 100(H) x 16(D) mm
 Compatible with Golmar MIFARE Classic and MIFARE+ cards, key fobs and remotes

**GM-IPOP CHAMP** 20720007

Proximity reader 13,56MHz with 2SAFE protocol
 For iP-Opener and EASYGATE controllers
 Status indicator light
 Embedded installation in front panels
 Diameter of fretwork: 25.5 mm
 43(Ø) x 7(D) mm
 Compatible with Golmar MIFARE Classic and MIFARE+ cards, key fobs and controllers

**GM-IPOP 80D** 20720006

13,56MHz proximity reader and Bluetooth with 2SAFE protocol
 Illuminated keypad for PIN code access
 Vandal-proof and waterproof housing
 For iP-Opener and EASYGATE controllers
 Status indicator lights
 Outdoor wall installation
 85(W) x 90(H) x 25(D) mm
 Compatible with Golmar MIFARE Classic and MIFARE+ cards, key fobs and controllers
 Bluetooth activation via K-APP mobile application (requires BLE points)



GM-IPOP-SQ40 20720022

13,56MHz proximity reader and Bluetooth with 2SAFE protocol

Vandal-proof and waterproof housing
For iP-Opener and EASYGATE controllers
Status indicator light

Embedded installation in front panels

Dimensions: 40(W) x 40(H) x 2(D) mm

60(W) x 60(H) x 16(D) mm

Compatible with Golmar MIFARE Classic and MIFARE+ cards, key fobs and controllers

Bluetooth activation via K-APP mobile application (requires BLE points)



GM-KR-IPOP 20780215

Keypad for PIN code access with 2SAFE protocol

Vandal-proof and waterproof housing
For iP-Opener controllers

Status indicator light

Illuminated keypad with Braille marking

Installation via embedding box included

Embedded: 95(W) x 125(H) x 40(D) mm

External: 100(W) x 135(H) mm



VIS-GM-KR-IPOP 20700135

Keypad visor GM-KR-IPOP



EL4500/2SAFE 11814505

13,56MHz proximity reader and Bluetooth with 2SAFE protocol

For iP-Opener and EASYGATE controllers

Status indicator light

Installation in N3xx1/AL and NX3xx1 modules of Nexa panels

Compatible with Golmar MIFARE Classic and MIFARE+ cards, key fobs and controllers

Bluetooth activation via K-APP mobile application (requires BLE points)



S3501/2SAFE 12583505

13,56MHz proximity reader and Bluetooth with 2SAFE protocol

For iP-Opener and EASYGATE controllers

Status indicator light

Installation on Supra panels (1/2 height)

Compatible with Golmar MIFARE Classic and MIFARE+ cards, key fobs and controllers

Bluetooth activation via K-APP mobile application (requires BLE points)



GM-WRIPOP 20780209

868MHz radio frequency receiver with 2SAFE protocol

For iP-Opener controllers

IP67 protection rating

Outdoor wall installation

91(W) x 155(H) x 34(D) mm

Compatible with GM-WEIPOP and GM-WEIPOP MF+ controls



ANT-WRIPOP 20700100

Passive external antenna for GM-WRIPOP receiver

NEW

WCONTROL

Single door controller with Wi-Fi connectivity



LOCAL MODE

- ▷ Card/key fob acquisition mode
- ▷ Data transfer between controllers

TUYA APP

- ▷ Remote opening
- ▷ User management
- ▷ Creation of single-use and temporary access codes
- ▷ Alarm notification, call button, ...
- ▷ Event monitoring

WCONTROL

20730010

Non-expandable 1-access controller with WIEGAND protocol
 Wi-Fi connectivity
 Status indicator lights
 Requires internet connection for use through the TUYA app
 Compatible with KEYBUS SE and BLE-S readers
 Local activation via readers or remote activation via TUYA app
 Capacity for up to 1,000 (local programming) or 500 users (remote programming via TUYA app)
 Relay output (NO, C, NC)
 Requires 12Vdc power supply.
 48(W) x 91(H) x 20(D) mm



KIT-KEYBUSW

20700150

Access control kit with proximity reader and numeric keypad

- | | |
|----------|--|
| 20730010 | WCONTROL controller for 1 access |
| 20720001 | Proximity reader with numeric keypad KEYBUS SE |
| 10900012 | HRF-12/1,25A power supply unit |



KIT-BLESW

20700151

Access control kit with proximity reader

- | | |
|----------|----------------------------------|
| 20730010 | WCONTROL controller for 1 access |
| 20720003 | BLE-S proximity reader |
| 11812100 | 3 NFC/US cards |
| 11812125 | 3 TAGNFC/US key fobs |
| 10900012 | HRF-12/1,25A power supply unit |

WIEGAND 26 DEVICES



BIO-N

20720012

Stand-alone access control by fingerprint and proximity reader 125KHz
 Capacitive fingerprint sensor
 Wiegand 26 output for connection to iP-OPENER controller
 Light and acoustic indicator of operation
 Up to 899 user cards and 99 fingerprints
 Optional access control deactivation after entering 10 consecutive wrong fingerprints
 1 relay output (NO, C, NC) for door, with input for remote activation
 Programmable activation time (1 to 99 seconds) and output mode (pulse or steady)
 Tamper alarm
 Power supply by controller and 12 or 18VDC in stand-alone mode
 Compatible with PROKEY ID cards and TAGKEY ID key fobs
 IP66 protection rating
 Embedded installation through AP-1 box or wall mount installation through SBOX-PBL or SBOX-MT boxes
 Also available for Supra (page 62) and Nexa (page 79)
 86(W) x 86(H) x 25(D) mm



CODEPROX-N

20720011

Stand-alone access control via keypad and proximity reader 125KHz
 Wiegand 26 output for connection to iP-OPENER controller (fingerprint management excluded)
 Light and acoustic indicator of operation
 Up to 990 users between codes and cards
 Optional deactivation of access control after entering 10 consecutive wrong codes
 1 relay output (NO, C, NC) for door, with input for remote activation
 Programmable activation time (1 to 99 seconds) and output mode (pulse or steady)
 Tamper alarm
 Power supply by controller and 12 or 18VDC in stand-alone mode
 Compatible with PROKEY ID cards and TAGKEY ID key fobs
 IP66 protection rating
 Embedded installation through AP-1 box or wall installation through SBOX-PBL or SBOX-MT boxes
 Also available for Supra (page 62) and Nexa (page 79)
 86(W) x 86(H) x 25(D) mm



SBOX-PBL

20700021

Plastic surface box
 For BIO-N and CODEPROX-N access controls
 88(W) x 88(H) x 30(D) mm



SBOX-MT

20700022

Metal surface box
 For BIO-N and CODEPROX-N access controls
 88(W) x 88(H) x 30(D) mm



AP-1

20363401

Embedding box
 For BIO-N and CODEPROX-N access controls
 81(W) x 81(H) x 60(D) mm

WIEGAND 26 DEVICES

**KEYBUS SE**

20720001

Stand-alone access control via keypad and dual proximity reader (125KHz and 13,56MHz)

Wiegand 26 output for connection to iP-OPENER and WCONTROL controllers

Light and acoustic indicator of operation

Up to 2,000 users

Optional access control lockout after entering 10 consecutive wrong codes or bad cards

1 relay output (NO, C, NC) for door, with input for remote activation

Programmable activation time (1 to 99 seconds)

Tamper alarm

Controller power supply and 12 to 24VDC in stand-alone mode

Compatible with Golmar 13,56MHz and 125KHz cards, keyfobs and keyfobs

IP68 protection rating

Outdoor wall installation

83(W) x 170(H) x 26(D) mm

**BLE-S**

20720003

Access control by dual proximity reader (125KHz and 13,56MHz)

Wiegand 26 output for connection to iP-OPENER and WCONTROL controllers

Light and acoustic indicator of operation

Powered by controller

Compatible with Golmar 13,56MHz and 125KHz cards, keyfobs and remotes

IP65 protection rating

Outdoor wall installation

48(W) x 100(H) x 23(D) mm

**BKEY SE**

20720021

Stand-alone access control by fingerprint and keypad

Optical fingerprint sensor

Wiegand 26 output for connection to iP-OPENER controller (fingerprint management excluded)

Light and acoustic indicator of operation

Up to 1.000 users per fingerprint and 1.000 per code

Optional access control deactivation after entering 10 consecutive wrong fingerprints

1 relay output (NO, C, NC) for door, with input for remote activation

Programmable activation time (1 to 99 seconds) and output mode (pulse or steady)

Tamper alarm

Power supply by controller and 12Vdc in stand-alone mode

IP66 protection rating

Outdoor wall installation

58(W) x 137(H) x 26(D) mm



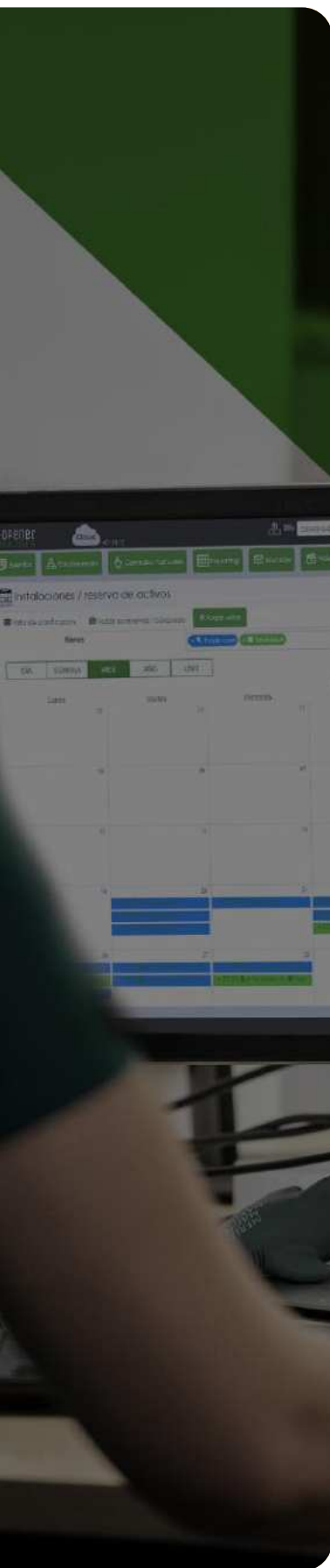

AIO-KEY

20720014

Stand-alone access control via keypad, fingerprint and dual proximity reader (125KHz and 13,56MHz)

Wi-Fi connectivity for remote activation via TUYA app (standalone mode only)

Wiegand 26 output for connection to iP-OPENER controller (fingerprint management excluded)

Light and acoustic indicator of operation

Up to 100 users per fingerprint, 888 per code or 500 with TUYA app

Optional access control lockout after entering 10 consecutive wrong codes or bad cards

1 relay output (NO, C, NC) for door, with input for remote activation

Programmable activation time (1 to 99 seconds)

Tamper alarm

Controller powered and 12 to 18Vdc in standalone mode

Compatible with Golmar 13,56MHz and 125KHz cards, keyfobs and remotes

IP66 protection rating

Outdoor wall installation

44(W) x 148(H) x 22(D) mm



GM-QRX3

20720051

Stand-alone access control by keypad, QR code and 13,56MHz proximity reader

Wiegand 26 output for connection to iP-OPENER controller

Light and acoustic indicator of operation

Power supply by controller and 12Vdc in stand-alone mode

Compatible with Golmar 13,56MHz cards, key fobs and remotes

IP66 protection rating

Outdoor wall installation

73(W) x 120(H) x 19(D) mm



GM-QRX2

20720050

Stand-alone access control using QR code and 13,56MHz proximity reader

Wiegand 26 output for connection to iP-OPENER controller

Light and acoustic indicator of operation

Power supply by controller and 12Vdc in stand-alone mode

Compatible with Golmar 13,56MHz cards, key fobs and remotes

Indoor wall installation

86(W) x 86(H) x 10(D) mm



CODEPROX-WL

20720015

Radio access control via keypad and proximity reader 13,56MHz

Receiver with Wiegand 26 output for connection to iP-OPENER controllers

20 m range in open field

Light and acoustic indicator of operation

Powered by controller (receiver) and 3 AAA batteries (transmitter, not included)

Compatible with Golmar cards, key fobs and 13,56MHz remotes

IP65 protection rating (transmitter)

Outdoor wall installation

55(W) x 134(H) x 20(D) mm

STAND-ALONE DEVICES



KEYPAD/P 20740429

KEYPAD/Z 20740428

Stand-alone access control via numeric keypad
 IK10 vandal-resistant housing (Z model)
 LED and acoustic operation indicators
 Up to 100 user codes
 2 relay outputs (NO, C, NC), with 1 input for remote activation
 Programmable activation time (1 to 99 seconds) and output mode (pulse or steady)
 12/24VAC or DC power supply.
 IP65 protection rating
 Outdoor wall installation
 83(W) x 120(H) x 36(D) mm



PROXEM 20720009

Stand-alone access control by proximity reader
 125KHz
 Light and acoustic indicator of operation
 Up to 2,000 users
 Optional deactivation of access control after entering 10 consecutive wrong codes
 1 relay output (NO, C, NC) for door, with input for remote activation
 Programmable activation time (1 to 99 seconds) and output mode (pulse or steady)
 Power supply from 9 to 18Vdc.
 Compatible with PROKEY ID cards and TAGKEY ID key fobs
 IP66 protection rating
 Outdoor wall installation
 48(W) x 103(H) x 19(D) mm



STAND-ALONE RADIO DEVICES

**TRO** 20760308

1-channel expansion card
For REC and WAVE 500-2 receivers

**ACT** 20769030

Coverage extension antenna
For REC and WAVE 500-2 receivers

EMITTER CONTROLS

**GM-WEIPOP** 20780210**GM-WEIPOP MF+** 20710025

4-channel transmitter at 868MHz
Proximity 13,56MHz MIFARE+ (MF+ model)
Push buttons with Braille marking and push button indicator lamp
Compatible with GM-WRIPOP receiver and 2SAFE protocol readers
Range up to 100 m in open field
Powered by CR2032 battery (included)
38(W) x 77(H) x 11(D) mm

Discover the latest version of our **GM-WEIPOP MF+** transmitter with 13.56MHz RF and proximity technology, further enhancing the security and reliability of access control systems.

The main upgrade is its **MIFARE+ encryption**, which integrates the robust Crypto-1.AES 128, providing a **higher level of security against threats and unauthorized access**.

Like its previous version, it remains compatible with GM-WRIPOP RF receivers and readers with 2SAFE technology.

PROXIMITY CARDS AND KEY FOBs

**ISOPROX** 20750500

13,56MHz proximity card
MIFARE Classic technology
Without customization
Unit of sale: 6

**CARDDOOR MF+** 20710009

13,56MHz proximity card
MIFARE+ Technology
AES128 encryption with 2SAFE protocol
Unit of sale: 10

**ISOPROX-PER BN/1C** 20710002

13,56MHz proximity card
MIFARE Classic technology
Black and white personalization on one side
Sales unit: 100

**TAGDOOR MF+** 20780208**TAGDOOR MF+ BLUE** 20710011**TAGDOOR MF+ RED** 20710012**TAGDOOR MF+ GREEN** 20710013**TAGDOOR MF+ ORANGE** 20710014**TAGDOOR MF+ YELLOW** 20710015**TAGDOOR MF+ WHITE** 20710020

Proximity key fob 13,56MHz
MIFARE+ Technology
AES128 encryption with 2SAFE protocol
35(W) x 48(H) x 7(D) mm
Sales unit: 20

**ISOPROX-PER BN/2C** 20710004

13,56MHz proximity card
MIFARE Classic technology
Personalization in black and white on two sides
Sales unit: 100

**ISOPROX-PER COL/1C** 20710003

13,56MHz proximity card
MIFARE Classic technology
One-sided color personalization
Sales unit: 100

**TAGDOOR-4K-EV** 20710010

Proximity key fob 13,56MHz
MIFARE+ Technology
AES128 encryption with 2SAFE protocol
Allows up to 100 events to be stored in
EASYGATE controller
35(W) x 48(H) x 7(D) mm
Sales unit: 20

**ISOPROX-PER COL/2C** 20710005

13,56MHz proximity card
MIFARE Classic technology
Two-sided color personalization
Sales unit: 100

**KEYPROX SE** 20710016

Proximity key fob 13,56MHz
MIFARE Classic technology
35(W) x 48(H) x 7(D) mm
Sales unit: 20

**PULDOOR MF+** 20710001

13,56MHz proximity bracelet
MIFARE+ Technology
AES128 encryption with 2SAFE protocol
Special for sports activities
Sales unit: 100



PUNTOS BLE 20710510

Points for use of BLE function in iP-OPENER controllers
Allows access via smartphone
Requires K-APP App (available on Android and iOS)
Unit of sale: 50



NFC/US 11812100

13,56MHz proximity card
Customised with Golmar logo



TAGNFC/US 11812125

Proximity key fob 13,56MHz
Customised with Golmar logo
32(W) x 40(H) x 4(D) mm



PROKEY ID 20710008

125KHz proximity card
Customised with Golmar logo



TAGKEY ID 20710007

Proximity key fob 125KHz
Customised with Golmar logo
32(W) x 40(H) x 4(D) mm



NEOKEY 20760401

Proximity key fob 125KHz
Only for CITYPROX-7M reader
36(W) x 47(H) x 11(D) mm

CARD AND KEY FOB PROGRAMMERS



GM-USBIPOP 20780206

Card and key fob programmer
Connection to computer via USB port
Compatible with Golmar MIFARE Classic and MIFARE+ cards, key fobs and remotes
118(W) x 135(H) x 34(D) mm



GM-USB-125 20700130

Card and key fob programmer
Connection to computer via USB port
Compatible with PROKEY ID and TAGKEY ID cards and key fobs
97(W) x 63(H) x 14(D) mm

POWER SUPPLIES



TF-104 20691040

12VAC transformer
230VAC / 18VA power supply
52(W) x 90(H) x 60(D) mm (3 DIN)



HRF-12/1,25A 10900012

12VDC/1.25A power supply unit
Power supply between 85 and 264VAC.
18(W) x 90(H) x 60(D) mm (1 DIN)



PSU-121B 31690146

12VDC/1.3A power supply unit
Power supply between 88 and 264VAC.
51(W) x 28(H) x 63(D) mm



12VAC-DC-CONV 20700037

12VAC to 12VDC converter.
Input voltage between 10 and 28VAC.
Output voltage 12VDC/2A
46(W) x 32(H) x 19(D) mm

UHF IDENTIFICATION



GM-UHF-LR 20720041

Long range UHF antenna (902 - 928MHz)
 Wiegand 26 output for connection to iP-
 OPENER controllers
 Stable reading distance between 7 and 9 m
 Includes 12Vdc local power supply.
 IP65 protection rating
 Includes clamp and screws for pole mounting
 445(W) x 445(H) x 40(D) mm



GM-UHF-WINDSHIELD 20710043

Plastic UHF windshield label
 111(W) x 45(H) mm
 Unit of sale: 10



GM-UHF-CARD 20710040

UHF Card



GM-UHF-PULDOOR 20710044

UHF wristband
 Unit of sale: 10



GM-UHF-LABEL 20710041

UHF Plastic Tag
 74(W) x 22(H) mm
 Unit of sale: 10



GM-USB-UHF 20700101

UHF programmer / credential reader
 Connection to computer via USB port
 107(W) x 107(H) x 23(D) mm



GM-UHF-LAUNDRY 20710042

UHF plastic garment tag
 74(W) x 15(H) mm
 Unit of sale: 50

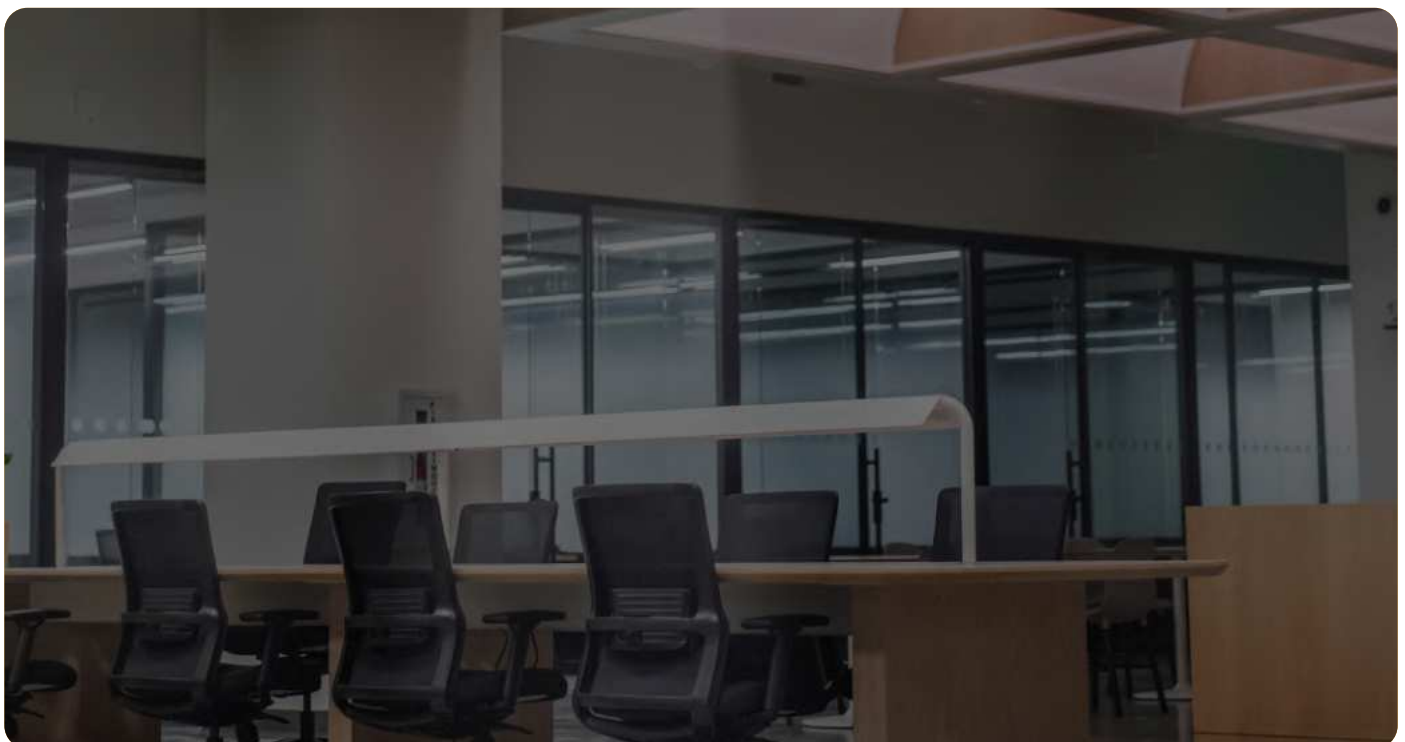

WIRELESS HANDLES

H100B8R-EU

20700044

Right hand wireless handle

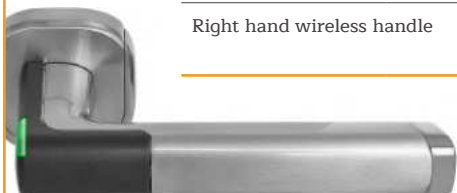
**H100B8L-EU**

20700043

Left hand wireless handle



Wireless handles with 13,56MHz proximity reader
 IEEE 802.15.4 (2.4 GHz) radio standard with Aperio protocol and AES128 encryption
 Requires AH30 HUB hub
 Operation indicator light
 Powered by CR123A battery (included), with a life of 30 openings per day for 4 years
 Installation on wooden, steel and tubular interior doors with European (DIN) locks, as well as glass doors
 For door leaves from 35 to 80 mm thick with 7 or 8 mm shafts
 EN 1634 certified for fire doors
 Compatible with Golmar MIFARE Classic and MIFARE+ cards, key fobs and remotes

**HUB AH30**

20700040

Concentrator for up to 64 wireless handles with Aperio protocol
 Distance between handle and concentrator up to 25 m (82 ft)
 Connection to iP-OPENER controllers via RS485
 Indoor installation via universal embedding box (not included)
 82(W) x 82(H) x 37(D) mm

**500ZB-RD-USB**

20700042

USB adapter
 For pairing Aperio devices

**APERIO-IPOP**

20710517

License to use Aperio on iP-OPENER controllers
 Requires one license per controller

**500ZB-EXTANT**

20700041

Coverage extension antenna
 For HUB AH30 hub

PUSH BUTTONS AND SWITCHES

**DUALB-N** 20700125

Dual output push button (mechanical or proximity push)
Adjustable reading range from 3 to 20 cm
Indicator light
1 relay output (NO, C, NC)
12 to 24Vdc power supply in stand-alone mode
Indoor wall installation by means of PB-SBOX-SN surface box
40(W) x 115(H) x 33(D) mm

**TLB-SQ-SS** 20700027

Proximity exit push button
Stainless steel AISI304
Adjustable reading range from 5 to 15 cm
Indicator light
1 relay output (NO, C, NC)
12 to 24Vdc power supply in stand-alone mode
IP68 protection rating
Outdoor wall installation by means of surface box PB-SBOX-SQ
86(W) x 86(H) x 25(D) mm

**TLB-N** 20700005

Proximity exit push button
Adjustable reading range from 5 to 15 cm
Indicator light
1 relay output (NO, C, NC)
12 to 24Vdc power supply in stand-alone mode
Indoor wall installation by surface box PB-SBOX-N
70(W) x 115(H) x 24(D) mm

**PB-N** 20700003

Mechanical exit push button
Output contact NO, C
Installation on internal metal profiles
28(W) x 91(H) x 25(D) mm

**TLB-SQ** 20700006

Proximity exit push button
Adjustable reading range from 5 to 15 cm
Indicator light
1 relay output (NO, C, NC)
12 to 24Vdc power supply in stand-alone mode
Indoor wall installation by means of surface box PB-SBOX-SQ
86(W) x 86(H) x 24(D) mm

**PB-SQ** 20700004

Mechanical exit push button
Output contact NO, C
Indoor wall installation by means of surface box PB-SBOX-SQ
86(W) x 86(H) x 25(D) mm

**PB-N-SS** 20700026

Mechanical exit push button
Stainless steel AISI304
Output contact NO, C
Indoor wall installation by means of PB-SBOX-SN surface box
40(W) x 115(H) x 25(D) mm

**TLB-N-SS** 20700028

Proximity exit push button
Stainless steel AISI304
Adjustable reading range from 5 to 15 cm
Indicator light
1 relay output (NO, C, NC)
12 to 24Vdc power supply in stand-alone mode
IP68 protection rating
Outdoor wall-mounted installation using PB-SBOX-N surface-mounted box
70(W) x 115(H) x 24(D) mm

**PB-SQ-SS** 20700025

Mechanical exit push button
Stainless steel AISI304
Output contact NO, C
Indoor wall installation by means of surface box PB-SBOX-SQ
86(W) x 86(H) x 25(D) mm

PB-SETA-N 20700030

Mushroom-type mechanical exit push button
Stainless steel AISI304
Output contact NO, C, NC
Indoor wall installation by surface box PB-SBOX-N
70(W) x 115(H) x 25(D) mm

KS-SQ 20700010

Mechanical key switch
Including 2 keys
Output contact NO, C, NC
Indoor wall installation by means of surface box PB-SBOX-SQ
86(W) x 86(H) x 30(D) mm

PB-SETA-SQ 20700029

Mushroom-type mechanical exit push button
Stainless steel AISI304
Output contact NO, C, NC
Indoor wall installation by means of surface box PB-SBOX-SQ
86(W) x 86(H) x 25(D) mm

PB-SBOX-SN 20700032

Metal surface-mounted box for exit push button
45(W) x 115(H) x 28(D) mm

PB-SBOX-SQ 20700034

Metal surface-mounted box for exit push button
86(W) x 86(H) x 28(D) mm

PB-SBOX-N 20700033

Metal surface-mounted box for exit push button
70(W) x 115(H) x 28(D) mm

GM-PEV-EM-SE 20700031

Mechanical evacuation push button with interlocking device
Key-operated reset
Trip indication pop-up tab
Output contact NO, C, NC
Indoor wall installation
92(W) x 97(H) x 59(D) mm

HES-125 20700007

HES-1356 20700008

Proximity card switch
Compatible with Golmar 125KHz (HES-125) and 13,56MHz (HES-1356) cards
Switching at 230VAC.
Indoor flush-mount installation via universal box (not included)
86(W) x 86(H) x 35(D) mm





technical information



G2+ 2-wire non-polarised	142
iPG+ TCP/IP protocol	146
4+N Analog	148
Access control	150

G 2+ | digital technology
2-wire non-polarised

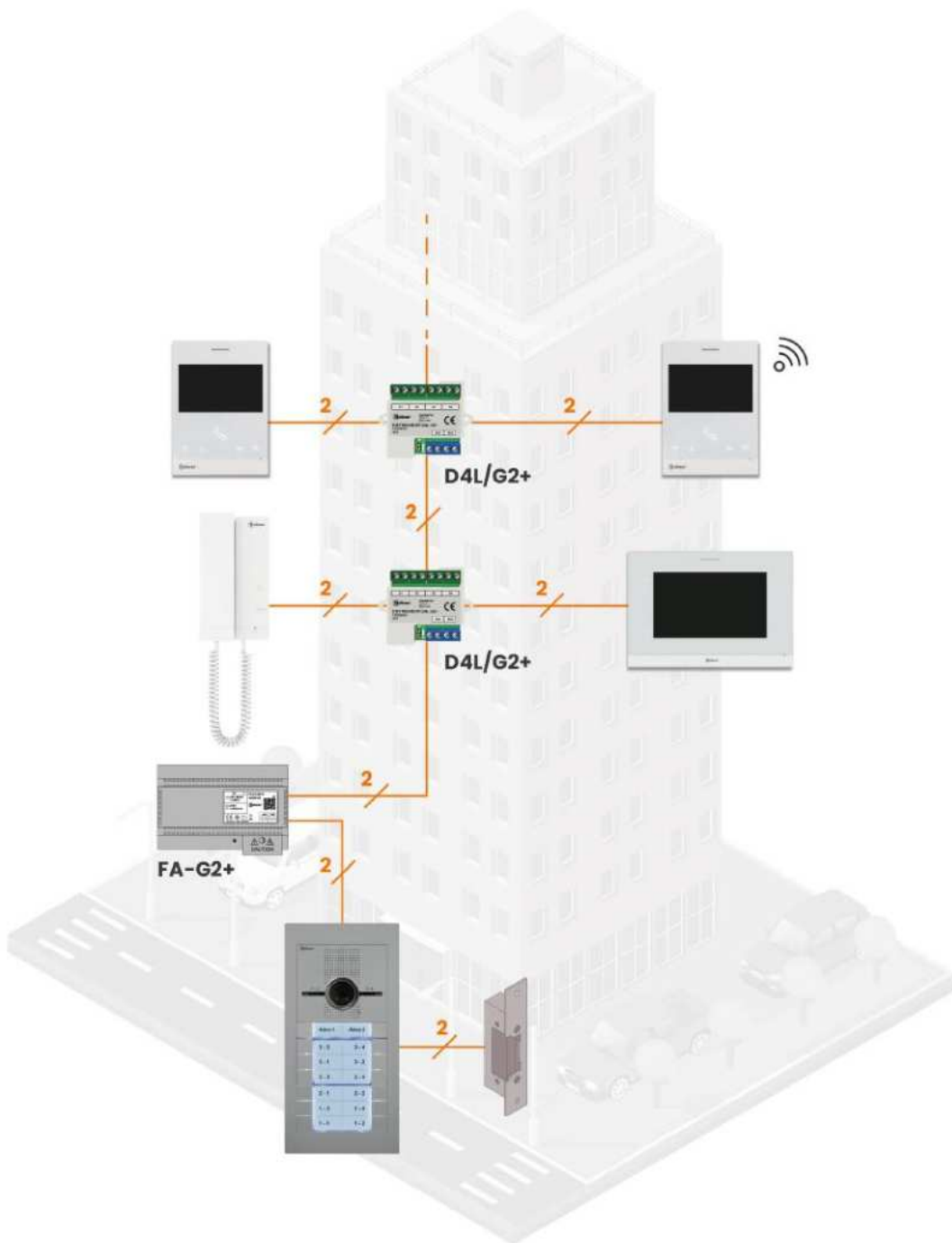

ONE ACCESS DOOR

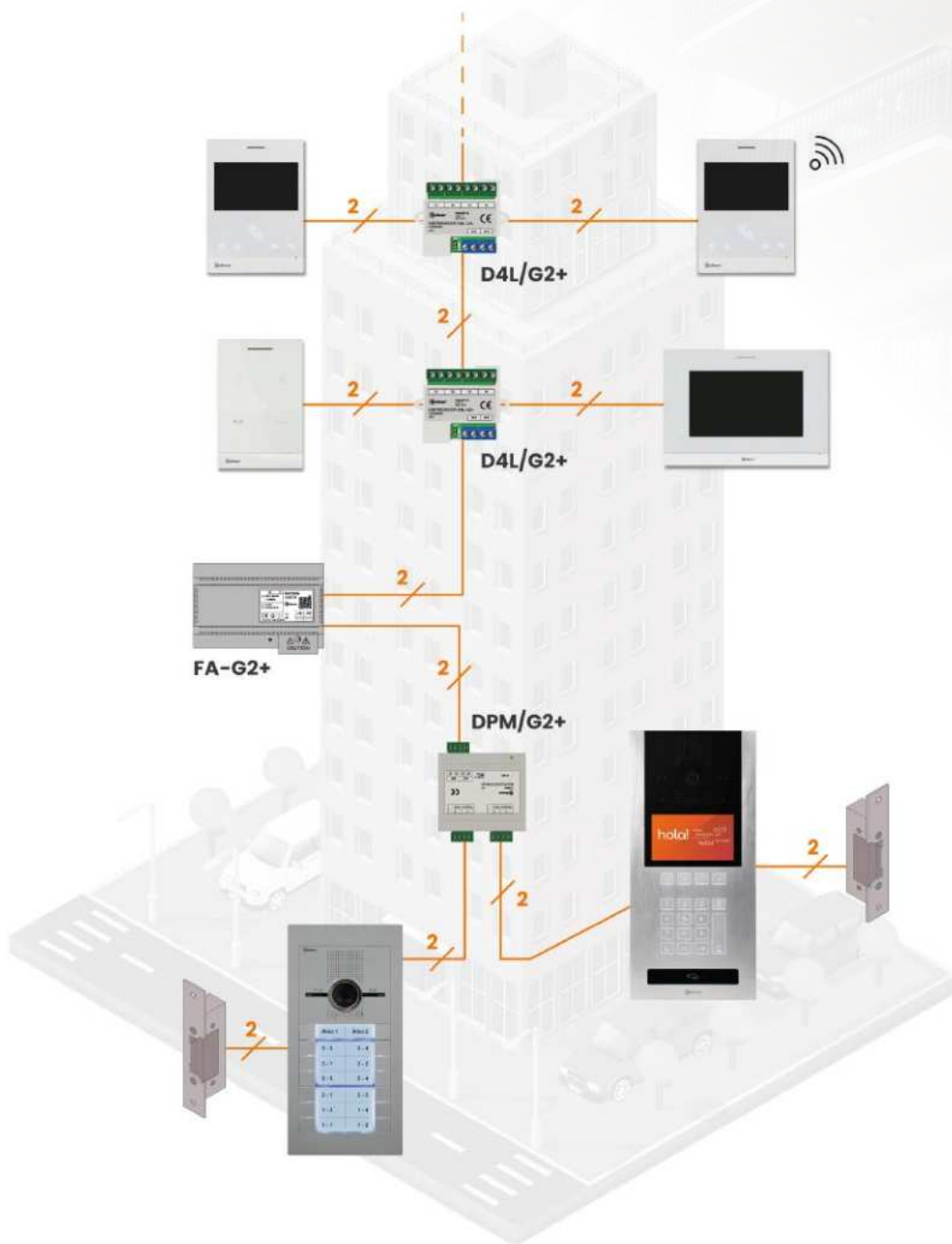

MULTIPLE ACCESS DOORS (UP TO 16)



G2+ | digital technology 2-wire non-polarised

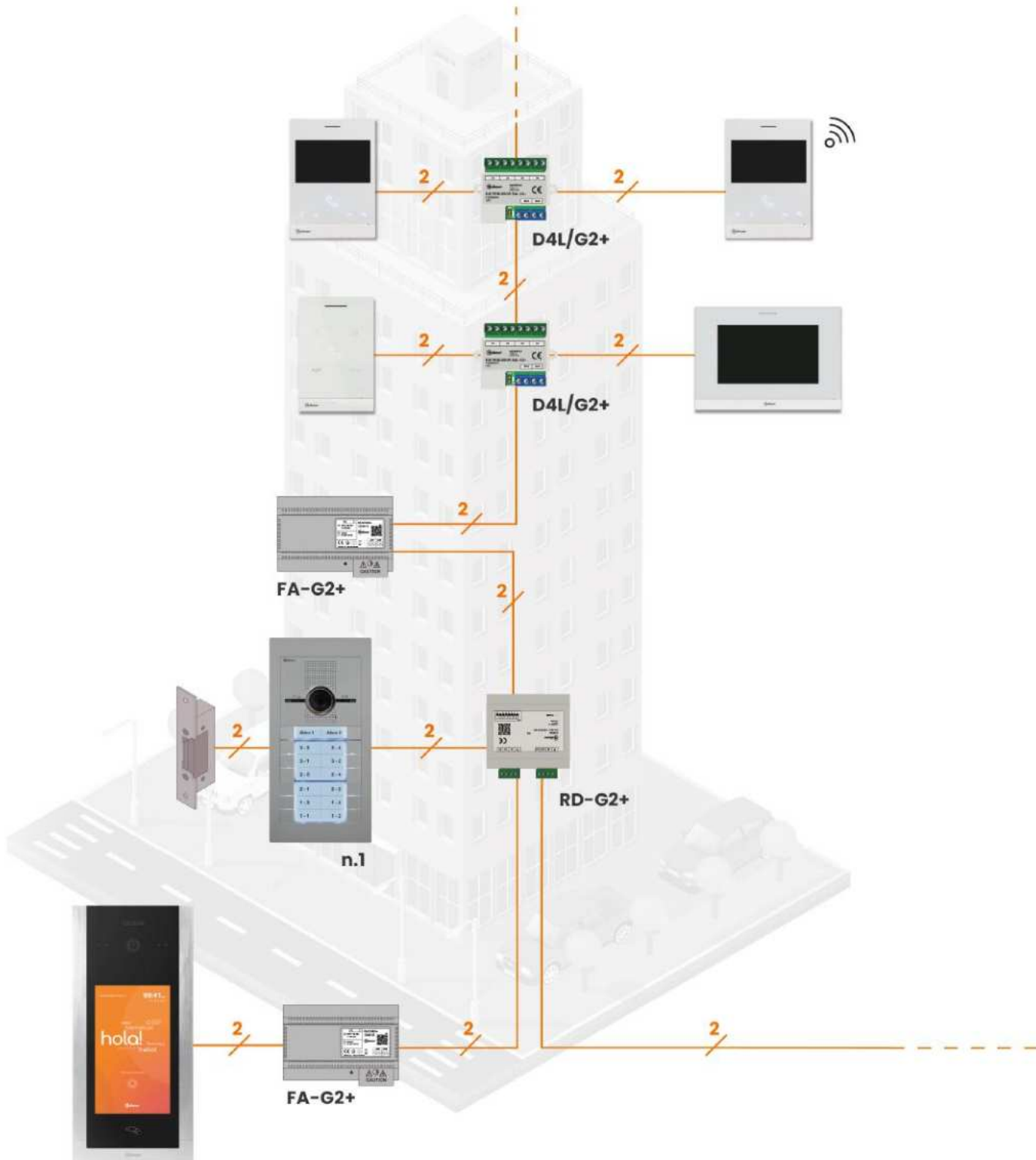

UP TO 4 GENERAL PANELS AND 32 INTERIOR BUILDINGS

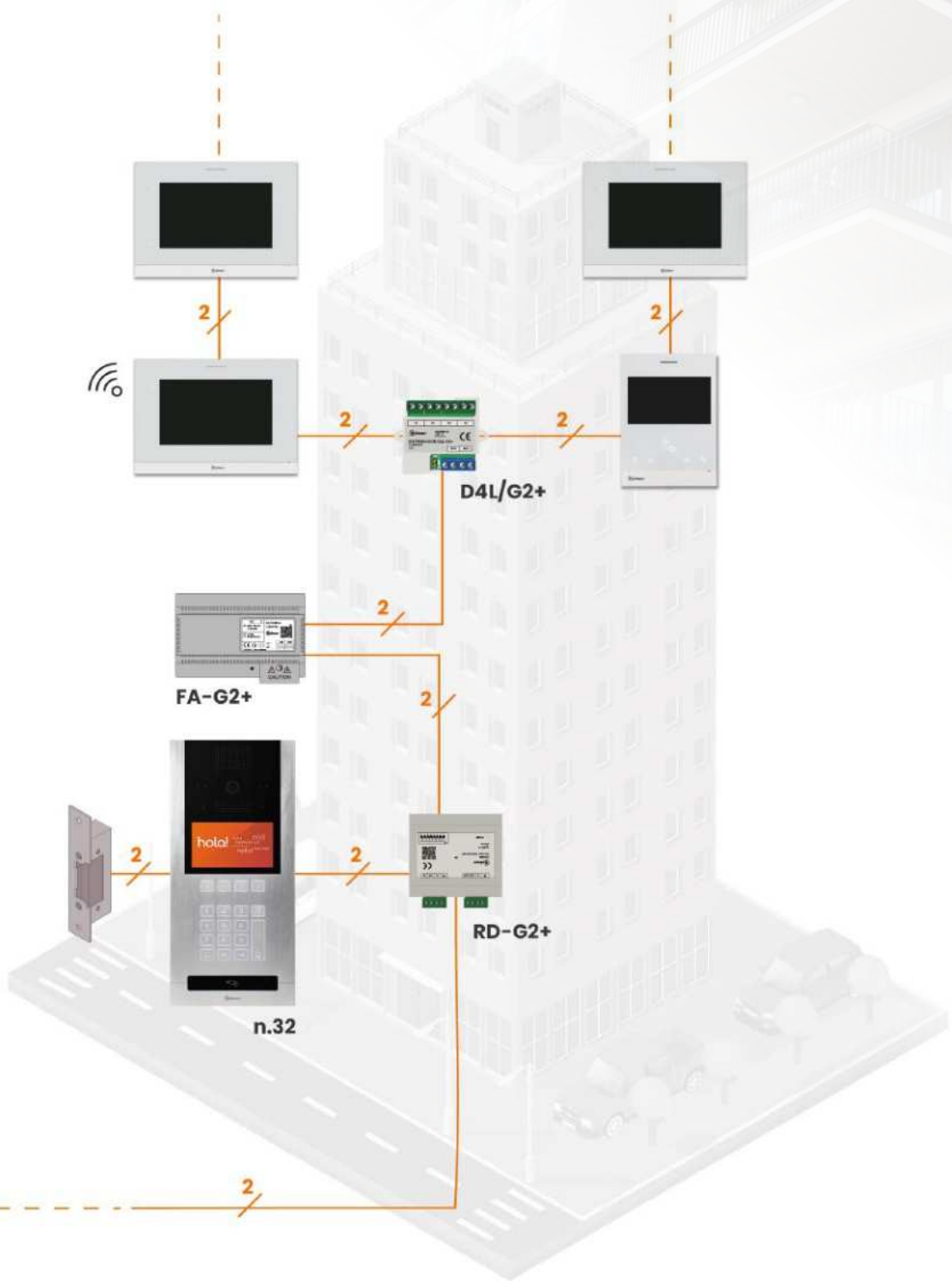

iPG+ | digital technology
TCP/IP protocol

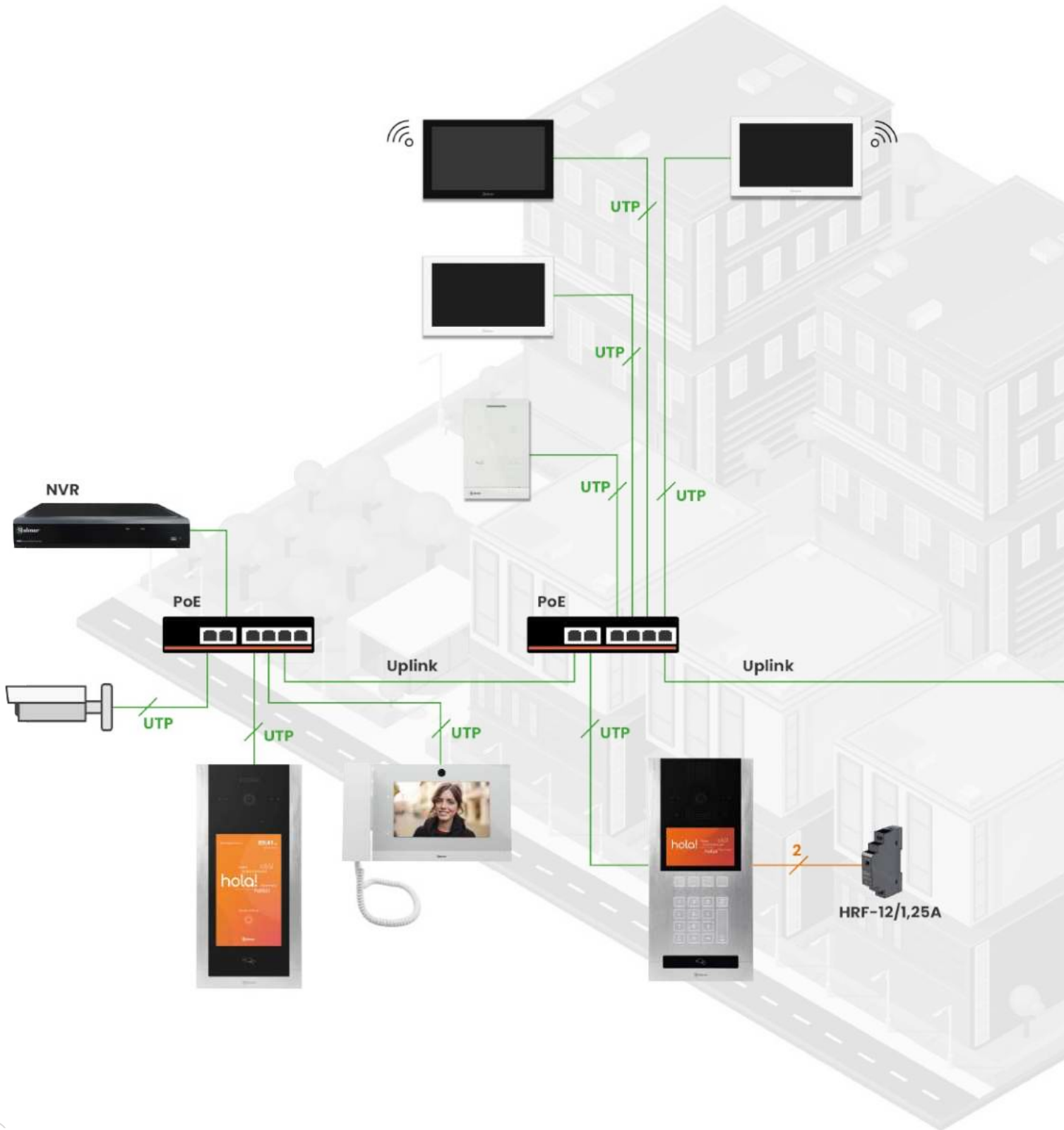

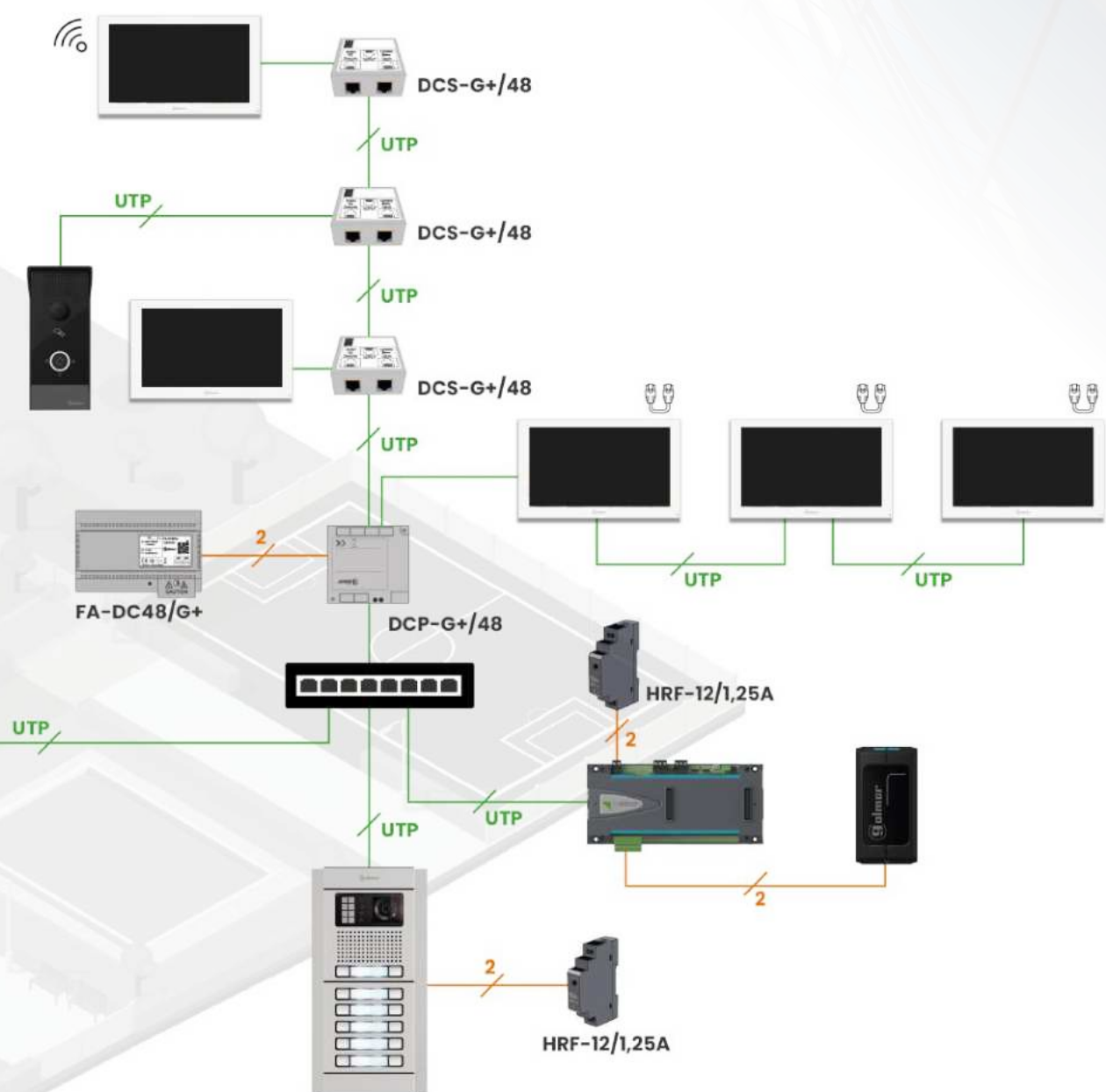



4 + N

conventional analogue technology

4 common wires + N apartments

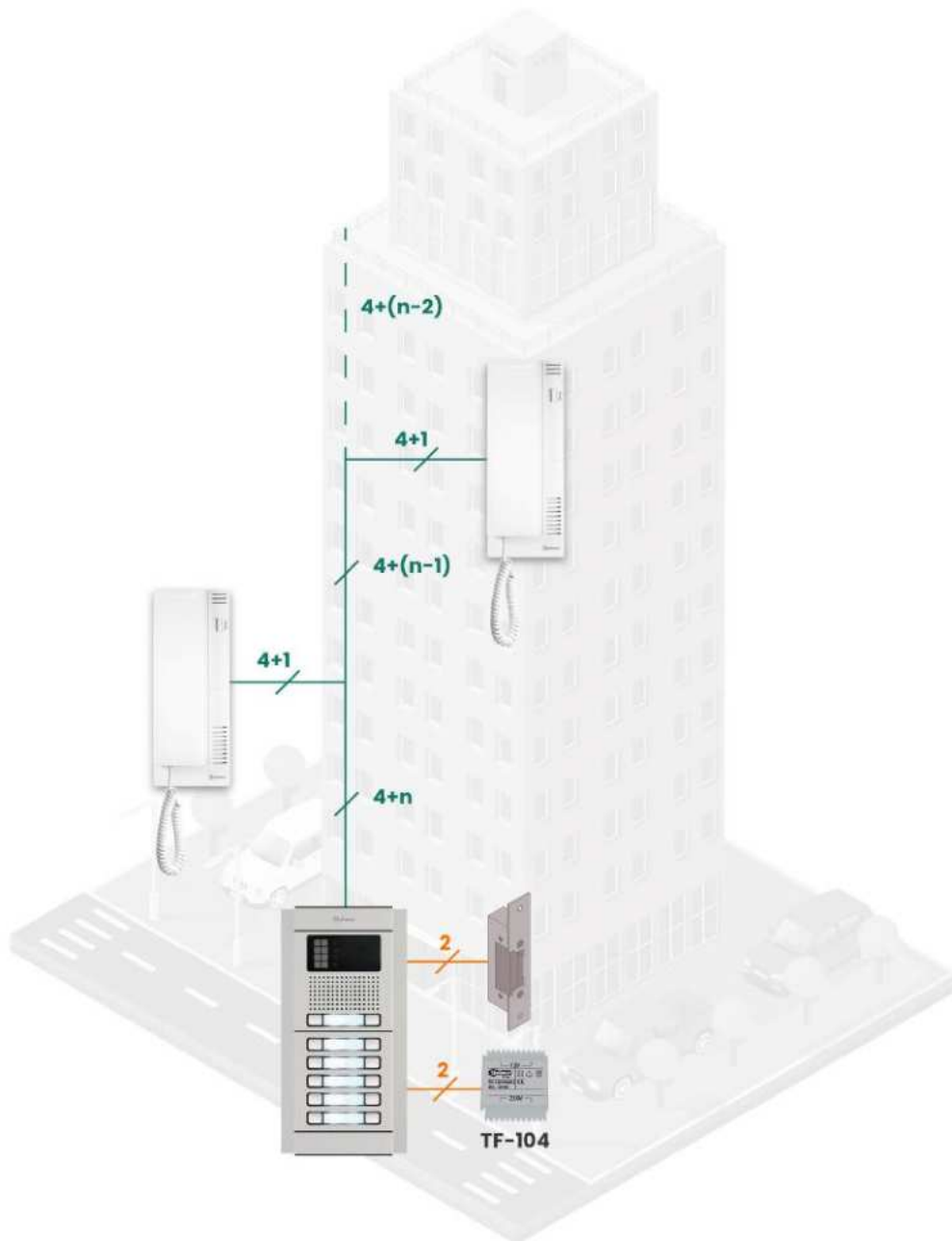

ONE ACCESS DOOR (EL655 SOUND MODULE)

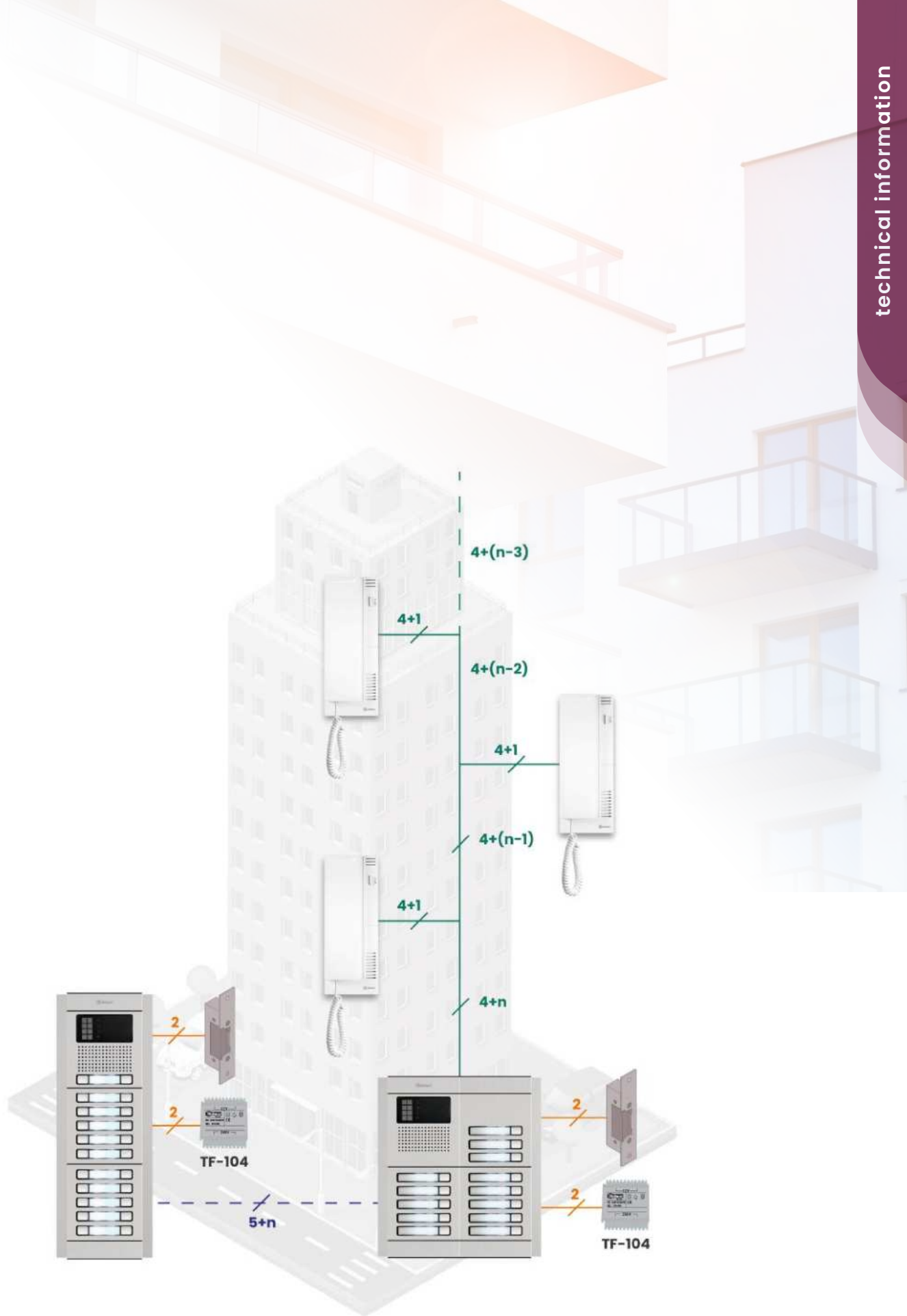

MULTIPLE ACCESS DOORS (EL651 SOUND MODULES)

Access control

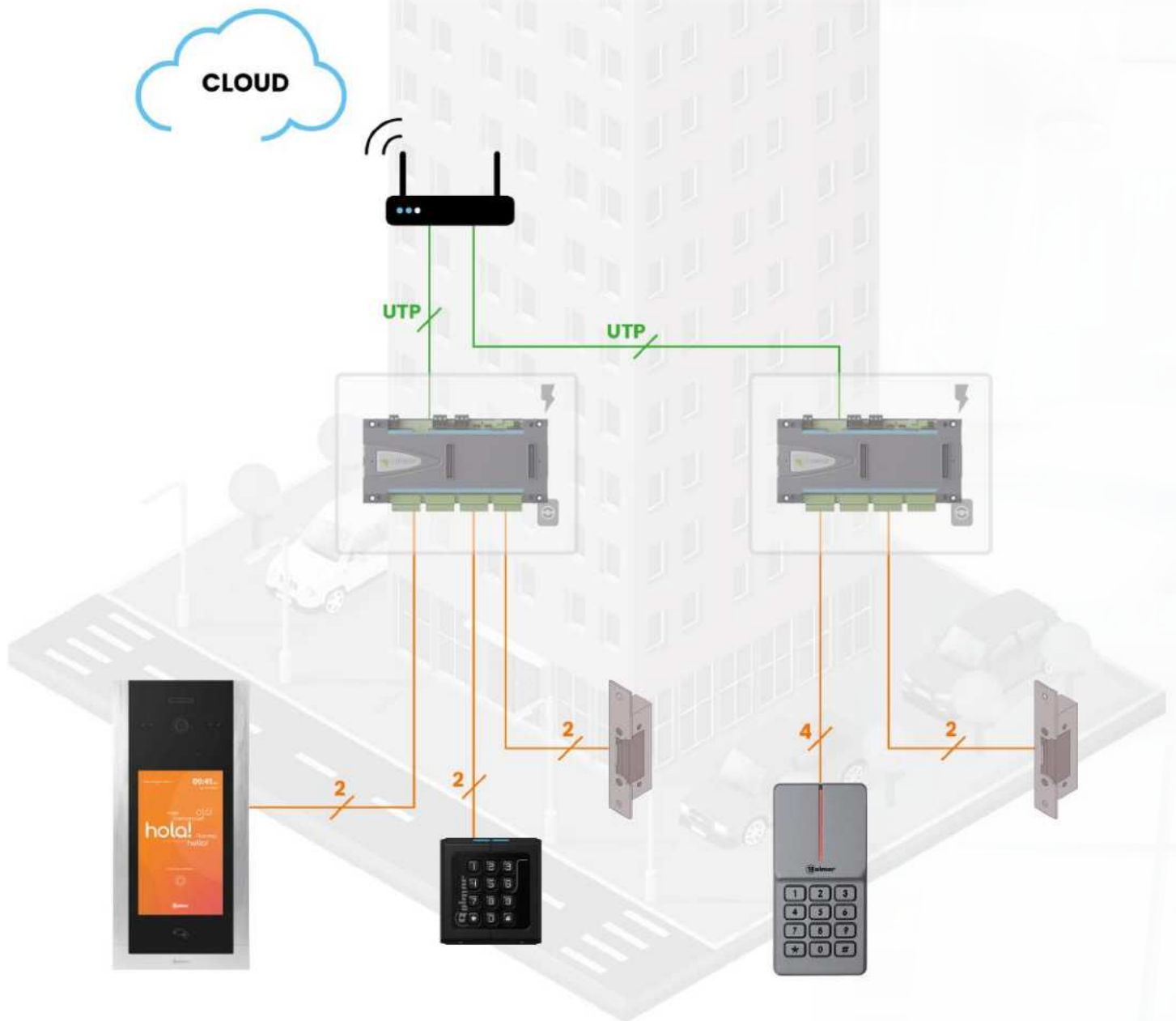







spare parts



Reference	Code	Description
ALT-NEXA	19950127	Nexa panel loudspeaker. 8 ohms / 40 mm
ALT-STADIO	19950126	Loudspeaker for Stadio panels. 8 ohms / 2"
AUR-ART 4TH/G2+	19950153	Handset for ART monitors and central concierge units
AUR-T-ART/G2+	19950151	Handset for T-ART telephones
AUR-TK/H	19920179	Handset for Tekna monitors with 3.5" display. Textured finish
AUR-TK/SLIM	19950146	Handset for Tekna S monitors with 4.3" screen. Polished finish
AUR/T-500	19950150	Pack of 2 handsets for 500 series phones. Textured finish
BORNAS-G2+	19950167	Set of 3 removable connection terminals. For DIN devices with G2+ technology
BORNAS-GB2	19950118	Set of 5 removable connection terminals. For DIN devices with GB2+ technology
CAB-NEXA	19950100	Upper and lower closing headers for Nexa panel
CAR-TK/PLUS	19950136	Housing for Tekna and Platea Plus monitors with 3.5" display
CORD-ART/G2+	19950152	Telephone cord for ART telephones, monitors and guard units
CORD-ART RJ11	19929940	Telephone cord for all series of telephones and monitors (except ART models)
CRT-NEXA/G2+	19950148	Camera mask covers for Nexa panel (2 units). G2+ and G+ technologies
CRT-NX632	19950130	Camera mask covers for Nexa panel (3 units). Plus, Vista Plus, GB2 and GTwin technologies
EL502	11798502	DC/AC converter module for Stadio panels
EL562	11780562	Twisted pair video receiver module for Tekna Plus and Platea Plus monitors. Sales unit: 5
EL562S	11780564	Twisted pair video receiver module for Tekna S Plus monitor. Sales unit: 5
FA-22/122/372	19950144	Power supply for Surf video kits
LAMP 24ST	19921546	Push-button illumination bulb for Stadio panels. 24V/3W. Sales unit: 25
LTG-BNX	19950133	Digital module connection cable for Nexa panels. Length: 500 mm.
MIC-60	19921550	Microphone with rubber holder for 60 Series panels
MIKRA-SPARE	19950099	Front housing for Mikra panel
PUL-NEXA D	19950102	Double push-button with label holder for Nexa panels
PUL-NEXA S	19950101	Single push-button with label holder for Nexa panels
PUL-ROCK INOX	19950111	Single push-button with label holder for Rock Inox panels
PUL-S90 N	19921568	Individual black push-button with label holder for Series 90 panels
PUL-STADIO D	19921565	Double push-button with label-holder for Stadio panels
PUL-STADIO S	19921571	Single push-button with label holder for Stadio panels
R-1000/AL	19981000	Stadio panel video grille module. Without push-buttons
R-1001/AL	19981001	Stadio panel video grille module. Without push-buttons. Informative window module
R-1110/AL	19981110	Stadio panel video grille module. 1 push-button
R-1111/AL	19981111	Stadio compact video module with closing headers. 1 push-button
R-1121/AL	19981121	Stadio compact video module with closing headers. 2 individual push-buttons
R-1150/AL	19981150	Stadio compact video module with closing headers. 5 single push-buttons
R-1220/AL	19981220	Stadio panel video grille module. 2 push-buttons
R-2000/AL	19982000	Stadio panel audio grille module. Without push-buttons
R-2001/AL	19982001	Stadio panel audio grille module. Without push-buttons. Informative window module
R-2110/AL	19982110	Stadio panel audio grille module. 1 push-button
R-2130/AL	19982130	Stadio compact audio module with closing headers. 3 individual push-buttons
R-2150/AL	19982150	Stadio compact audio module with closing headers. 5 single push-buttons
R-2210/AL	19982210	Stadio compact audio module with closing headers. 10 double push-buttons
R-2220/AL	19982220	Stadio panel audio grille module. 2 push-buttons

Reference	Code	Description
R-2260/AL	19982260	Stadio compact audio module with closing headers. 6 double push-buttons
R-3000/AL	19983000	Stadio panel blind module
R-3001/AL	19983001	Stadio panel small informative window module
R-3002/AL	19983002	Large Stadio panel informative window module
R-3110/AL	19983110	Module 1 push-button Stadio panel
R-3111/AL	19983111	Module 1 push-button Stadio panel. Informative window module
R-3120/AL	19983120	Module of 2 single push-buttons Stadio panel
R-3130/AL	19983130	Module of 3 individual push-buttons Stadio panel
R-3131/AL	19983131	Module of 3 individual push-buttons Stadio panel. Informative window module
R-3140/AL	19983140	Module of 4 individual push-buttons Stadio panel
R-3150/AL	19983150	Module of 5 individual push-buttons Stadio panel
R-3210/AL	19983210	Module of 10 double push-buttons Stadio panel
R-3220/AL	19983220	Module of 2 double push-buttons Stadio panel
R-3221/AL	19983221	Module of 2 double push-buttons Stadio panel. Informative window module
R-3240/AL	19983240	Module of 4 double push-buttons Stadio panel
R-3241/AL	19983241	Module of 4 double push-buttons Stadio panel. Informative window module
R-3260/AL	19983260	Module of 6 double push-buttons Stadio panel
R-3280/AL	19983280	Module of 8 double push-buttons Stadio panel
R-3403/AL	19953403	Coded module Stadio panel
R-600/AL	19980600	Upper and lower header for Stadio panels
R-A-490	19950163	Power supply for Series 90 digital systems
R-ACC-SUPRA	19950154	Screws, strips, hinge, screwdriver, retaining tabs and rear/front rubbers for Supra panels
R-CAM-GB2	19980162	Outdoor colour camera with 2-wire installation. GB2 technology
R-CAR-SOUL	19925401	Front housing for 1 push-button Soul panel
R-CAR-SOUL/B	19925401B	Front housing for 1-button Soul panel. Black colour
R-CD-NEXA/BT	19998195	Radio programmer for Nexa coded panels
R-CD-Plus/4N	19958196	Digital converter from Plus to 4+n technology
R-CETK-590 Plus	19969715	Central guard unit. Plus technology
R-D2L-GB2	19950162	Two-output video distributor. GB2 technology
R-D4L-PLUS	19988994	Four-output video distributor via coaxial cable. Plus and 90 Series Technologies
R-D4L-PLUS/RJ45	19988996	Four-output video distributor over twisted pair with RJ45 connection. DIN 4. Plus technology
R-D4L-R5	19958995	Four-output video distributor. Vista Plus Technology (R5)
R-D4L-R5R	19959001	Four-output video distributor. Reduced size. Vista Plus Technology (R5)
R-DP-CAM-GB2	19980261	Converter for external analog camera connection to EL642/GB2A audio modules. GB2 technology
R-DP-GB2A	19960162A	Switching unit for four panels (DIN 4). GB2 technology
R-EL3422/GB2	19903424	Display module for Nexa coded panels. GB2 technology
R-EL500/R5	19950505	Microprocessor module for Stadio push-button panels. Vista Plus Technology (R5)
R-EL500/V2PLUS	19950502	Microprocessor module for Stadio push-button panels. V2Plus technology
R-EL500TE	19950500A	Microprocessor module for Stadio push-button panels. Plus technology
R-EL512	19991512	Relay module for Stadio panels
R-EL516SE	19980526	Push-button encoder module for Stadio panels. Plus, Vista Plus(R5) and V2Plus technologies
R-EL531	19950531	Sound module with colour camera for Stadio panels. Plus, Vista Plus(R5) and V2Plus technologies
R-EL540	19950540	Sound module for Stadio panels. Plus, Vista Plus(R5) and V2Plus technologies

Reference	Code	Description
R-EL551	19930551	Sound module for Stadio panels. 4+n technology with electronic call. Several access doors
R-EL555	19980555	Sound module for Stadio panels. 4+n technology with electronic call or buzzer. One access door
R-EL560	19980560	Twisted pair video transmitter module for EL500 modules of Stadio panels. Plus technology
R-EL564	19998564	Coaxial to twisted pair video converter
R-EL620/2PLUS	19918620	Sound module for Nexa panels. 2Plus technology
R-EL632/GB2B	19930162B	Sound module with colour camera for Nexa panels. GB2 technology
R-EL632/PLUS	19917632	Sound module with colour camera for Nexa panels. Plus technology
R-EL632/R5	19915632	Sound module with colour camera for Nexa panels. Vista Plus Technology (R5)
R-EL642/PLUS	19917642	Sound module for Nexa panels. Plus technology
R-EL642/R5	19915642	Sound module for Nexa panels. Vista Plus Technology (R5)
R-EL732/PLUS-R5	19980635	Sound module with colour camera for Supra panels. Plus and Vista Plus technologies (R5)
R-FA-GB2/B	19940162B	Power supply. GB2 technology
R-FA-PLUS/C	19905107A	Power supply. Plus and Vista Plus technologies (R5)
R-FA-V2PLUS	19950164	Power supply. V2Plus technology
R-M-IP-GB2	19970362	Image memory module for Vesta 2SE monitors. GB2 technology
R-N3301/GB2	19903301	Keypad module for Nexa Aluminum coded panels. GB2 technology
R-N3401/GB2	19903401	Navigation and RFID reader module for Nexa Aluminum coded panels. GB2 technology
R-NHEA GB2	19920140	Nhea hands-free indoor unit. GB2 technology
R-NHEA PLUS SE	19900140	Nhea hands-free indoor unit. Plus technology
R-NX3301/GB2	19903302	Keypad module for Nexa Inox coded panels. GB2 technology
R-NX3401/GB2	19903402	Navigation module and RFID reader for Nexa Inox coded panels. GB2 technology
R-PENTHA GB2	19910241	Pentha hands-free monitor with 7" touch screen. GB2 technology
R-PVS-295 GRF COL	19939506A	Rock video panel with colour camera with 1 push-button. Plus technology
R-RD-GB2/A	19950262A	Digital repeater. GB2 technology
R-RD-PLUS/UNO TE	19998210	Digital repeater. Plus technology
R-S-45	19990045	Call repeater. V2Plus technology
R-SAR-GB2	19990100	Digital relay unit. GB2 technology
R-SOUL-4.3/LITE	19925505	Soul video panel with 1 push-button. G2+ technology
R-SU-R5	19990021	Relay unit for connection of second camera and door opener. Only for "SU-R5" monitors and telephones
R-SU3-PLUS	19905130	Three-panel switching unit. Plus technology
R-SZENA PLUS SE	19984026	Szena hands-free monitor with 3.5" display. Plus technology
R-T-530/R5	19905530	Replacement for the T-730/R5 telephone. Vista Plus Technology (R5)
R-T-540 PLUS SE	19905545	Replacement T-740 Plus and T-940 Plus phones. Plus technology
R-T-540 UNO SE	19905540	Replacement T-740 Uno and T-940 Uno phones. Plus technology
R-T-562	19920162	Digital telephone. GB2 technology
R-T-5720	19905720	Replacement for T-7720 phone. 2Plus technology
R-T-5822VD	19905533	Replacement of T-7720 and T-7822 VD phones. 2Plus and V2Plus technologies
R-TEKNA-HF R5	19942510	Tekna hands-free monitor with 4.3" screen. Vista Plus Technology (R5)
R-TEKNA-S PLUS	19942126	Replacement of Shiner, Platea and Tekna monitors. Plus technology
R-TEKNA-S R5	19942525	Replacement of Platea and Tekna monitors. Vista Plus Technology (R5)
R-VESTA2 SE GB2	19910139B	Vesta hands-free monitor with 4.3" screen. GB2 technology
R-VESTA7 SE GB2	19910140A	Vesta hands-free monitor with 7" screen. GB2 technology
RCTK-PLUS	11742080	Tekna monitor connection strip

Reference	Code	Description
SET-GB2	1995039	Wall mounting screws, installation connectors and cable with special functions for monitors with GB2 technology
SET-ROCK	19950124	Vandal-proof locking screws in different colours, special key, push-button and display for Rock panels
T-590VD	19950590	Replacement of T-840 and T-790VD telephones. 90 Series Technology
TEKNA 90 TE	19950142	Replacement of Shiner and Platea monitors. 90 Series Technology
TM-500N	20761050	User expansion card for REC receiver
TOR-CODE INOX	19950110	Fixing screws and screwdriver tip for coded Rock Inox panels
TOR-NEXA AL	19950125	Fixing screws and module separator for Nexa Aluminum panels
TOR-NEXA INOX	19950104	Fixing screws and screwdriver tip for Nexa Inox panels
VIS-90A	19921590	Informative window module for 90 Series panels
VIS-90V	19921591	Camera window for 90 Series panels
VIS-NEXA	19950103	Camera window for Nexa panels
VIS-ROCK INOX	19950112	Camera window for Rock Inox panels
VIS-ST	19950134	Camera window for Stadio panels. Includes adhesive gasket
VIS-STGR	19950131	Large informative window for Stadio panels
VIS-STIND	19950132	Small informative window for Stadio panels

Create your project

MAKE IT HAPPEN IN ONE CLICK

A simple and functional tool to design, visualise your project and obtain an estimate in a quick and accessible way.

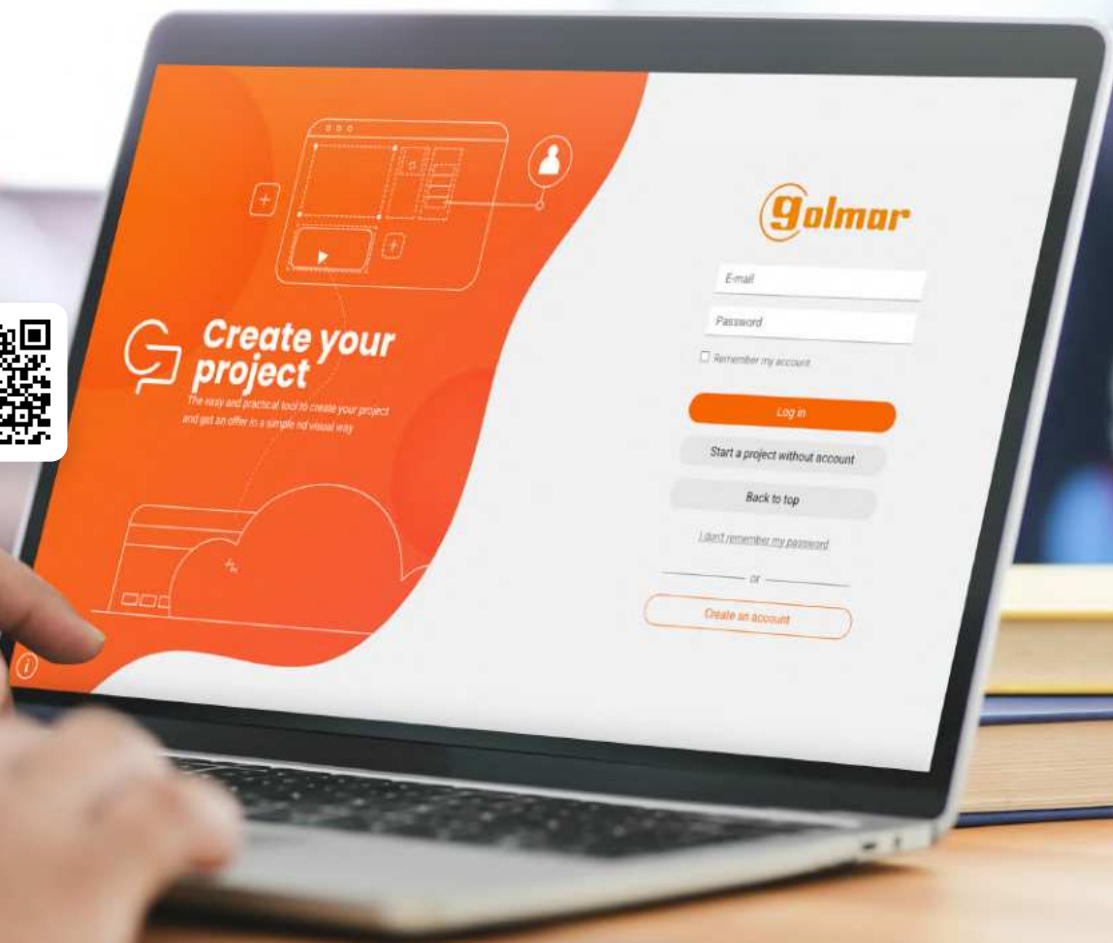

Create Your Project is an intuitive tool for configuring residential door entry and video door entry projects, allowing to customise door panels, accessories and indoor units.

Registered users can download a PDF quote with images, diagram and links to products.

In addition, Golmar customers can modify the quotation, adapt it in Excel and send it directly to our systems for its management.



Choose technology

Our systems are adapted to your installation in the most efficient way possible.



Choose from all our products

We offer a wide range of products to meet the needs of all users.



Visualise your project

Take a preview of the installation you want to implement



Get a detailed quotation

So you have an idea of the total cost of your installation - no surprises!

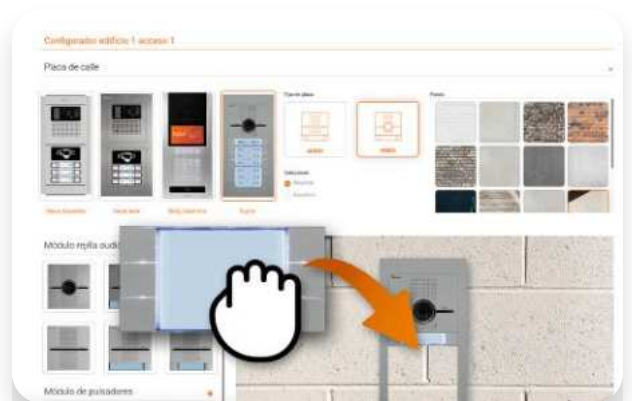

Drag & drop system

With the drag & drop system in Create Your Project, you can easily drag and drop the modules you need. Explore our wide range of options and customise your door panel quickly and easily, ensuring that each component fits your needs perfectly.

All solutions in one place.

Visit our redesigned support website, where you will find answers to your questions and solutions for your projects. Access product documentation and manuals, manage repairs and request quotes easily with our new **Create Your Project** tool.

soporte.golmar.es

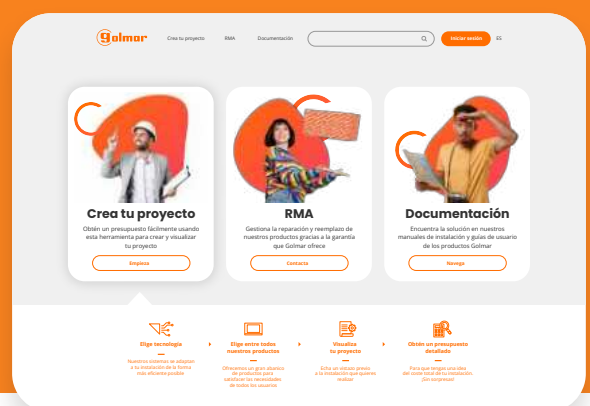

Supra

compositions

		2	4	6	8	10	12	14	16	
	S1000/AL		1	1		1	1		1	
	S1220/AL	1			1			1		
	EL732/G2+	1	1	1	1	1	1	1	1	
	S3000/AL		1	1	1				1	
	S3240/AL		1			1			1	
	S3260/AL			1	1	1	2	2	2	
	EL706D		1	1	1	2	2	2	3	
	S6001/AL	1								
	S6002/AL		1	1	1	1	1	1		
	S6003/AL								1	
	S6004/AL									
	CE610	1								
	CE620		1	1	1	1	1	1		
	CE630								1	
	CE640/SUPRA									
	FA-G2+	1	1	1	1	1	1	1	1	
	RD-G2+									
	D4L-G2+	1	1	2	2	3	3	4	4	



	18	20	22	24	26	28	30	32	34	36	38
	1		1	1		1	1		1	1	
		1			1			1			1
	1	1	1	1	1	1	1	1	1	1	1
	1	1				1	1	1			
			1			1			1		
	3	3	3	4	4	4	5	5	5	6	6
	3	3	4	4	4	5	5	5	6	6	6
	1	1	1	1	1						
						1	1	1	1	1	1
	1	1	1	1	1						
						1	1	1	1	1	1
	1	1	1	1	1	1	1	1	2	2	2
									1	1	1
	5	5	6	6	7	7	8	8	9	9	10





references

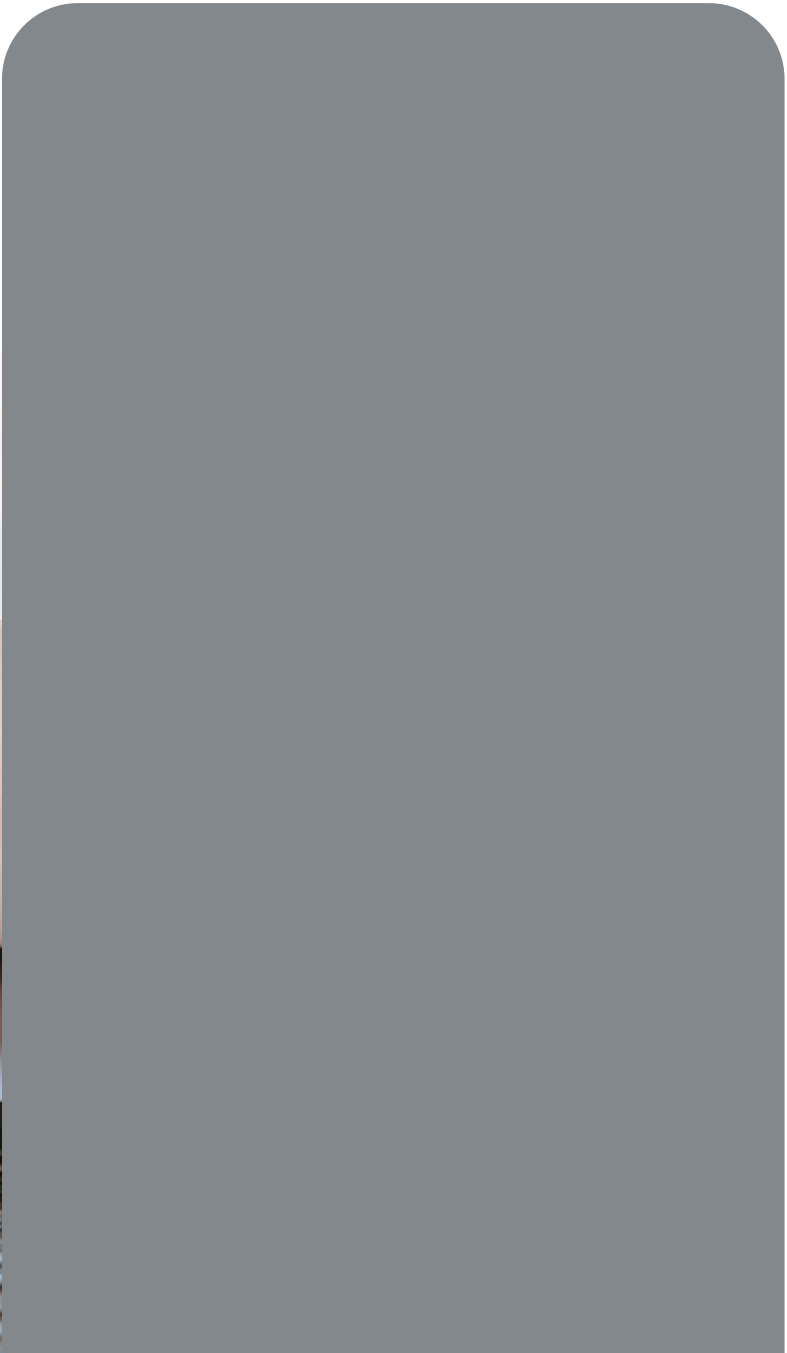

Reference	Code	Page
12VAC-DC-CONV	20700037	135
500ZB-EXTANT	20700041	137
500ZB-RD-USB	20700042	137
6502/G+	12326502A	72
6502/G+/2SAFE	12326502A2	72
6502/G+/2SAFE BLACK	12326502B2	72
6502/G+/2SAFE INOX	12326502X2	72
6502/G+ BLACK	12326502B	72
6502/G+ INOX	12326502X	72
6502/G2+	12226502A	72
6502/G2+/2SAFE	12226502A2	72
6502/G2+/2SAFE BLACK	12226502B2	72
6502/G2+/2SAFE INOX	12226502X2	72
6502/G2+/125KHZ	12226502A1	72
6502/G2+/125KHZ BLACK	12226502B1	72
6502/G2+/125KHZ INOX	12226502X1	72
6502/G2+ BLACK	12226502B	72
6502/G2+ INOX	12226502X	72
6502/INFO	12226503A	73
6502/INFO BLACK	12226503B	73
6502/INFO INOX	12226503X	73
6507/G+	12326507A	69
6507/G+/2SAFE	12326507A2	69
6507/G+/2SAFE BLACK	12326507B2	69
6507/G+/2SAFE INOX	12326507X2	69
6507/G+ BLACK	12326507B	69
6507/G+ INOX	12326507X	69
6507/G2+	12226507A	69
6507/G2+/2SAFE	12226507A2	69
6507/G2+/2SAFE BLACK	12226507B2	69
6507/G2+/2SAFE INOX	12226507X2	69
6507/G2+/125KHZ	12226507A1	69
6507/G2+/125KHZ BLACK	12226507B1	69
6507/G2+/125KHZ INOX	12226507X1	69
6507/G2+ BLACK	12226507B	69
6507/G2+ INOX	12226507X	69
7111	20607111	114
7113	20607113	114
ACT	20769030	133
AIO-KEY	20720014	131
ANT-WRIPOP	20700100	127
AP-1	20363401	129
APERIO-IPOP	20710517	137
ART 1/G+	12310140	106
ART 1/G2+	12210140	106
ART 4B LITE/G2+	12210435B	103
ART 4/G2+	12210430	103
ART 4H XLITE/G2+	12210432	103
ART 4TH/G+	12310400	103
ART 4TH LITE/G2+	12210400	103
ART 4WH/G2+	12210437	103
ART 4W LITE/G2+	12210445	103
ART 4 XLITE/G2+	12210436	103
ART 7B LITE/G2+	12210705B	103
ART 7H/G2+	12210702	103
ART 7 LITE/G2+	12210705	103

Reference	Code	Page
ART 7W/G2+	12210710	103
ARTIS/1/G2+	12221110	91
ARTIS/2/G2+	12221120	91
ARTIS/3/G2+	12221130	91
ARTIS/4/G2+	12221140	91
ARTIS/5/G2+	12221150	91
BAT-7A	21090070	125
BIO-N	20720012	129
BKEY SE	20720021	130
BLE-S	20720003	130
C5110/EDGE 7AW/G+	12305114	16
C5110/EDGE 7/G+	12305110	16
C5110/EDGE 7WB/G+	12305113B	17
C5110/EDGE 7W/G+	12305113	16
CABLE SOB-UNI	12192201	110
CARDDOOR MF+	20710009	134
CARDSET/5	12240460	21
CD-NEXA/G2+	12280615	78
CE-4M	11797890	81
CE-8M	11797892	81
CE610	11280610	63
CE610	11280610	81
CE620	11280620	63
CE620	11280620	81
CE630	11280630	63
CE630	11280630	81
CE640	11280640	81
CE640/SUPRA	12570950	63
CE-6502 SE	12396502B	73
CE-ART 7/G+	12379703	105
CE-ART 7/G2+	12279707	105
CE-ART 7W/G2+	12279704	105
CEV-90	11259906	81
CLIP/G+	12325701	17
CODEPROX-N	20720011	129
CODEPROX-WL	20720015	131
CV-14P/UNI/SF	20600155	114
CV-14 SEGUR 35	20600250	115
CV-14 SEGUR 50	20600251	115
CV-16P/UNI/SF	20600160	114
CV-24EP/UNI/SF	20600255	114
CV-24P/UNI/SF	20600253	114
CV-26EP/UNI/SF	20600159	114
CV-26P/UNI/SF	20600158	114
CV-34P/DC/SF	20600353	114
D2L-G2+	12258950	110
D4L-G2+	12258940A	110
D4L-G2+/DIN	12258940	110
DCP-G+/48	12358974	110
DCS-G+/48	12358971	110
DPM-G2+	12258955	118
DQ-IPCAM-G2+	12458990	118
DUALB-N	20700125	138
EASYGATE	20740440	125
EASYGATE-RF	20730005	125
EDGE 7AW/G+	12310754	101

Reference	Code	Page
EDGE 7/G+	12310751	101
EDGE 7/IO/G+	12310752	101
EDGE 7WB/G+	12310753B	101
EDGE 7W/G+	12310753	101
EL606D	12010606	77
EL610A	11818610	77
EL610D	11818612	77
EL632/G+/48	12325632A	76
EL632/G2+ SE	12225632A	76
EL642/G2+	12235642	76
EL651 SE	11818651A	76
EL655	11818655	76
EL706D	12580706	61
EL732/G2+	12580732	60
EL742/G2+	12580742	60
EL3002	11823002	78
EL3002H	11503002	78
EL4500/2SAFE	11814505	127
EL4502/NFC	11814502	79
EL4503/NFC	11814503	79
ESCUDO C/16/G	20690053	114
ESCUDO C/G	20690051	114
ESCUDO L/16/G	20690054	114
ESCUDO L/G	20690052	114
ESCUDO L/INOX	20690911	114
ESCUDO M/G	20690055	114
ESCUDO M/INOX	20690910	114
ESCUDO SU/G	20690061	114
FA-ART 7W	12240170	117
FA-DC48/G+	12340105	117
FA-G2+	12240100	117
GM-IPOP-1P	20780200	124
GM-IPOP-2P-WIEG	20730002	124
GM-IPOP-4P	20780202	124
GM-IPOP-10E-RS485	20730007	124
GM-IPOP-10S-RS485	20730004	124
GM-IPOP 40	20720004	126
GM-IPOP 80	20720005	126
GM-IPOP 80D	20720006	126
GM-IPOP CHAMP	20720007	126
GM-IPOP-EXP2P	20780211	124
GM-IPOP-EXP4PW	20730001	124
GM-IPOP-EXP12E	20780213	124
GM-IPOP-EXP12S	20780212	124
GM-IPOP-SQ40	20720022	127
GM-KR-IPOP	20780215	127
GM-MRIPOP	20780204	126
GM-ORIPOP	20780214	126
GM-PEV-EM-SE	20700031	139
GM-PSIPOP-G	20780125	125
GM-PSIPOP-M	20700023	125
GM-PSIPOP-S	20700080	125
GM-QRX2	20720050	131
GM-QRX3	20720051	131
GM-SRIPOP	20780205	126
GM-UHF-CARD	20710040	136

Reference	Code	Page
GM-UHF-LABEL	20710041	136
GM-UHF-LAUNDRY	20710042	136
GM-UHF-LR	20720041	136
GM-UHF-PULDOOR	20710044	136
GM-UHF-WINDSHIELD	20710043	136
GM-USB-I25	20700130	135
GM-USBIPOP	20780206	135
GM-USB-UHF	20700101	136
GM-WEIPOP	20780210	133
GM-WEIPOP MF+	20710025	133
GM-WRIPOP	20780209	127
H100B8L-EU	20700043	137
H100B8R-EU	20700044	137
HES-I25	20700007	139
HES-I356	20700008	139
HRF-12/1,25A	10900012	117
HRF-12/1,25A	10900012	135
HUB AH30	20700040	137
ISOPROX	20750500	134
ISOPROX-PER BN/1C	20710002	134
ISOPROX-PER BN/2C	20710004	134
ISOPROX-PER COL/1C	20710003	134
ISOPROX-PER COL/2C	20710005	134
K6-201 GRF	11242016B	43
K-201 GRF	11242014B	43
K-202 GRF	11242024B	43
KEYBUS SE	20720001	130
KEYPAD/P	20740429	132
KEYPAD/Z	20740428	132
KEYPROX SE	20710016	134
KIT-BLESW	20700151	128
KIT-KEYBUSW	20700150	128
KS-SQ	20700010	139
LCU-16/G+	12380616	118
M-8C	20120080	119
MAC-295/G	11295615	29
MAC-295/G	11295615	43
MAC-295/P	11295611	29
MAC-295/P	11295611	43
MAC-500	11298500	111
MAC-ART	12260100	111
MAC-M1	12260210	111
MAC-M2A	12260221	111
MAC-M2/ART	12260220A	111
MAC-M2-ART 4TH	12260223	111
MAC-M2-HOLES	12260222	111
MAC-M3	12260230	111
MAC-M3-HOLES	12260240	111
MAC-SOUL	12285611	21
MAC-SOUL	12285611	41
MAC-SOUL/ACCESS	12285612	25
MAC-SOUL/BLACK	12285611B	21
MP/GRF	11229509A	29
MP/GRF	11229509A	43
MP-VIS/GRF	11290496A	29
MP-VIS/GRF	11290496A	43

Reference	Code	Page
N611/911	11880001	85
N611/AL	11880620	37
N611/AL	11880620	49
N611/AL	11880620	53
N611/AL	11880620	55
N611/AL	11880620	85
N611/AL-C	11880624	37
N611/AL-C	11880624	49
N611/AL-C	11880624	53
N611/AL-C	11880624	55
N611/AL-C	11880624	85
N615/AL	11880615	86
N621/921	11880002	85
N621/AL	11880621	37
N621/AL	11880621	49
N621/AL	11880621	53
N621/AL	11880621	85
N621/AL-C	11880623	37
N621/AL-C	11880623	49
N621/AL-C	11880623	53
N621/AL-C	11880623	85
N621/ROCK	11792079	85
N622/AL	11880622	85
N622/AL-C	11880625	85
N631/931	11880003	85
N631/AL	11890631	37
N631/AL	11890631	49
N631/AL	11890631	85
N631/AL-C	11890633	37
N631/AL-C	11890633	49
N631/AL-C	11890633	85
N632/AL	11890632	85
N632/AL-C	11890634	85
N633/AL	11890635	85
N633/AL-C	11890636	85
N641/AL	11890641	85
N711/AL	11880711	36
N711/AL	11880711	49
N711/AL	11880711	53
N711/AL	11880711	55
N711/AL	11880711	82
N721/AL	11880721	36
N721/AL	11880721	49
N721/AL	11880721	53
N721/AL	11880721	82
N722/AL	11880722	82
N723/AL	11880723	82
N731/AL	11880731	36
N731/AL	11880731	49
N731/AL	11880731	82
N732/AL	11880732	82
N733/AL	11880733	82
N741/AL	11880741	82
N811/AL	11880811	36
N811/AL	11880811	49
N811/AL	11880811	53

Reference	Code	Page
N811/AL	11880811	55
N821/AL	11880821	36
N821/AL	11880821	49
N821/AL	11880821	53
N831/AL	11880831	36
N831/AL	11880831	49
N871/AL	11880871	37
N871/AL	11880871	49
N871/AL	11880871	53
N871/AL	11880871	55
N871/AL	11880871	83
N872/AL	11880872	37
N872/AL	11880872	49
N872/AL	11880872	53
N872/AL	11880872	83
N873/AL	11880873	37
N873/AL	11880873	49
N873/AL	11880873	83
N874/AL	11880874	83
N876/AL	11880876	83
N911/AL	11280912	37
N911/AL	11280912	49
N911/AL	11280912	53
N911/AL	11280912	55
N911/AL	11280912	85
N921/AL	11280913	37
N921/AL	11280913	49
N921/AL	11280913	53
N921/AL	11280913	85
N931/AL	11280914	37
N931/AL	11280914	49
N931/AL	11280914	85
N1000/AL	11881000	76
N1110/AL	11881110	76
N1130/AL	11881130	86
N1140/AL	11881140	86
N1220/AL	11881220	76
N1260/AL	11881260	86
N1280/AL	11881280	86
N2000/AL	11882000	76
N3000/AL	11883000	78
N3000/BIO-N	20700015	79
N3000/CODEPROX-N	20700017	79
N3001/AL	11883001	78
N3002/AL	11883002	78
N3110/AL	11883110	77
N3111/AL	11883111	77
N3120/AL	11883120	77
N3121/AL	11883121	77
N3130/AL	11883130	77
N3131/AL	11883131	77
N3140/AL	11883140	77
N3150/AL	11883150	77
N3210/AL	11883210	77
N3220/AL	11883220	77
N3221/AL	11883221	77

Reference	Code	Page
N3240/AL	11883240	77
N3241/AL	11883241	77
N3260/AL	11883260	77
N3261/AL	11883261	77
N3280/AL	11883280	77
N3301A/AL	11885301	78
N3301/AL	11883301	78
N3301/AL	11883301	78
N3403/AL	11883404	78
N4101/T-ART	12404101	46
N4110/T-500	11854110	51
N4130/T-500	11854130	52
N4140/T-500	11854140	52
N4150/T-500	11854150	52
N4160/T-500	11854160	52
N4202/T-ART	12404202	46
N4204/T-ART	12404204	46
N4206/T-ART	12404206	46
N4208/T-ART	12404208	47
N4210/T-500	11854210	52
N4210/T-ART	12404210	47
N4212/T-500	11854212	53
N4212/T-ART	12404212	47
N4214/T-ART	12404214	47
N4216/T-ART	12404216	48
N4218/T-ART	12404218	48
N4220/T-500	11854220	51
N4220/T-ART	12404220	48
N4222/T-ART	12404222	48
N4280/T-500	11854280	52
N4301/AL	11884301	55
N4502/NFC	11884502	55
N5110/ART 4W LITE	12205111	33
N5110/ART 4 XLITE	12205112	33
N5110/ART 7 LITE	12205117	33
N5204/ART 4 XLITE	12415204	34
N5206/ART 4 XLITE	12415206	34
N5208/ART 4 XLITE	11863110	34
N5210/ART 4 XLITE	12415210	34
N5212/ART 4 XLITE	12415212	35
N5214/ART 4 XLITE	12415214	35
N5216/ART 4 XLITE	12415216	35
N5218/ART 4 XLITE	12415218	35
N5220/ART 4W LITE	12205221	33
N5220/ART 4 XLITE	12205222	33
N5220/ART 7 LITE	12205227	33
N5221/ART 4 XLITE	12415220	36
N5222/ART 4 XLITE	12415222	36
N6001/AL	11880601	80
N6002/AL	11880602	80
N6003/AL	11880603	80
N6004/AL	11880604	80
N6005/AL	11880605	86
N6011/AL	11880611	80
N6012/AL	11880612	80
N6013/AL	11880613	80

Reference	Code	Page
N6014/AL	11880614	80
N8741/AL	11880875	83
NCEV-90C	11880900	81
NCEV-90CS	11880902A	81
NEOKEY	20760401	135
NFC/IN	11812105	55
NFC/IN	11812105	62
NFC/US	11812100	17
NFC/US	11812100	55
NFC/US	11812100	62
NFC/US	11812100	73
NFC/US	11812100	79
NFC/US	11812100	135
NX611/ROCK	11792077	37
NX711	11881711C	36
NX711	11881711C	82
NX721	11881721C	82
NX722	11881722C	82
NX731	11881731C	82
NX732	11881732C	82
NX733	11881733C	82
NX741	11881741C	82
NX871	11881871C	37
NX871	11881871C	83
NX872	11881872C	83
NX873	11881873C	83
NX874	11881874C	83
NX876	11881876C	83
NX911	11881911	37
NX1000	11761000C	76
NX1110	11761110C	76
NX1220	11761220C	76
NX3000	11763000C	78
NX3000/BIO-N	20700016	79
NX3000/CODEPROX-N	20700018	79
NX3001	11763001C	78
NX3002	11763002C	78
NX3110	11763110C	77
NX3111	11783111C	77
NX3120	11763120C	77
NX3121	11783121C	77
NX3130	11763130C	77
NX3131	11783131C	77
NX3140	11763140C	77
NX3150	11763150C	77
NX3210	11763210C	77
NX3220	11763220C	77
NX3221	11783221C	77
NX3240	11763240C	77
NX3241	11783241C	77
NX3260	11763260C	77
NX3261	11783261C	77
NX3280	11763280C	77
NX3301	11883302C	78
NX3301	11883302C	78
NX3301A	11886301C	78

Reference	Code	Page
NX3403	11883405C	78
NX5110/ART 7W	12205119	32
NX6001	11776001C	80
NX6002	11776002C	80
NX6003	11776003C	80
NX6004	11776004C	80
NX8741	11881875C	83
PB-N	20700003	138
PB-N-SS	20700026	138
PB-SBOX-N	20700033	139
PB-SBOX-SN	20700032	139
PB-SBOX-SQ	20700034	139
PB-SETA-N	20700030	139
PB-SETA-SQ	20700029	139
PB-SQ	20700004	138
PB-SQ-SS	20700025	138
PROKEY ID	20710008	62
PROKEY ID	20710008	73
PROKEY ID	20710008	79
PROKEY ID	20710008	135
PROXEM	20720009	132
PSU-121B	31690146	135
PULDOOR MF+	20710001	134
PUNTOS BLE	20710510	135
PVS-295/G2+ GRF	12225295	29
R5110/ART 4W LITE	12205121	28
R5110/ART 4 XLITE	12205122	28
R5110/ART 7 LITE	12205127	28
R5110/ART 7W	12205129	28
RAP-100C	11895810	81
RAP-610A	11895610	81
RAP-610D	11895710	81
RAP-610D 100CM	11895720	81
RAP-GTWIN/HF	20160031A	119
RAP-GTWIN/HF 500M	20160033A	119
RAP-SUPRA	12590850	63
RC-EDGE	12390751	101
RC-EDGE/B	12390751B	101
RC-SOUL/ACCESS	12225433	25
RD-G2+	12258960	118
RES-IPOP	20710501	125
S-4	11290040	110
S-8	11290080	110
S611/AL	12570611	65
S621/AL	12570621	65
S622/AL	12570622	65
S631/AL	12570631	65
S632/AL	12570632	65
S633/AL	12570633	65
S641/AL	12570641	65
S711/AL	12570711	64
S711/BK	12570711B	64
S721/AL	12570721	64
S721/BK	12570721B	64
S722/AL	12570722	64
S722/BK	12570722B	64

Reference	Code	Page
S723/AL	12570723	64
S723/BK	12570723B	64
S731/AL	12570731	64
S731/BK	12570731B	64
S732/AL	12570732	64
S732/BK	12570732B	64
S733/AL	12570733	64
S733/BK	12570733B	64
S741/AL	12570741	64
S741/BK	12570741B	64
S871/AL	12570871	64
S871/BK	12570871B	64
S872/AL	12570872	64
S872/BK	12570872B	64
S873/AL	12570873	64
S873/BK	12570873B	64
S874/AL	12570874	64
S874/BK	12570874B	64
S911/AL	12570911	65
S911/BK	12570911B	65
S921/AL	12570921	65
S921/BK	12570921B	65
S922/AL	12570922	65
S922/BK	12570922B	65
S931/AL	12570931	65
S931/BK	12570931B	65
S932/AL	12570932	65
S932/BK	12570932B	65
S941/AL	12570941	65
S941/BK	12570941B	65
S1000/AL	12581000	60
S1000/BK	12581000B	60
S1110/AL	12581110	60
S1110/BK	12581110B	60
S1220/AL	12581220	60
S1220/BK	12581220B	60
S2000/AL	12582000	60
S2000/BK	12582000B	60
S2110/AL	12582110	60
S2220/AL	12582220	60
S2220/BK	12582220B	60
S3000/AL	12583000	61
S3000/BIO-N	12583315	62
S3000/BIO-N/BK	12583315B	62
S3000/BK	12583000B	61
S3000/CODEPROX-N	12583305	62
S3000/CODEPROX-N/BK	12583305B	62
S3001	12583001	61
S3001/H	12583001H	61
S3001/S	12583001S	61
S3120/AL	12583120	61
S3130/AL	12583130	61
S3240/AL	12583240	61
S3240/BK	12583240B	61
S3260/AL	12583260	61
S3260/BK	12583260B	61

Reference	Code	Page
S3301/AL	12583301	61
S3302/AL	12583302	61
S3303/AL	12583303	61
S3403/AL	12583403	61
S3501/2SAFE	12583505	127
S3501/NFC	12583501	62
S4110/ART 1	12204115	41
S4110/T-ART	12204110	41
S5110 ACCESS/ART 4	12205140	24
S5110 ACCESS/ART 4WH	12205145	24
S5110 ACCESS/ART 7H	12205170	24
S5110 ACCESS/ART 7W	12205175	24
S5110/ART 4B	12205114B	20
S5110/ART 4W LITE	12205114W	20
S5110/ART 4 XLITE	12205115	20
S5110/ART 7H	12205116H	20
S5110/ART 7 LITE	12205120	20
S5110/ART 7W	12205118	20
S6001/AL	12586001	63
S6001/BK	12586001B	63
S6002/AL	12586002	63
S6002/BK	12586002B	63
S6003/AL	12586003	63
S6003/BK	12586003B	63
S6004/AL	12586004	63
S6004/BK	12586004B	63
S7165/INFO	12397165M	73
S7165/INFO BLACK	12397165P	73
S7165 SE	12397165A	73
S7165 SE BLACK	12397165C	73
S7865/INFO	12397865M	73
S7865/INFO BLACK	12397865P	73
S7865 SE	12397865A	73
S7865 SE BLACK	12397865C	73
SAR-12/24	11291012	118
SAR-G+	12358965	118
SAR-G2+	12258965	118
SAV-12	12480260	110
SBOX-MT	20700022	129
SBOX-PBL	20700021	129
SEAL BIT +	20630001	119
SEAL BIT 2+	20630002	119
SOB-UNI	12192202	110
SOUL/1	12225401	21
SOUL/1A	12234401	41
SOUL/1B	12225401B	21
SOUL/2	12225402	21
SOUL/2A	12234402	41
SOUL/4	12225404	21
SOUL/4A	12234404	41
SOUL/ACCESS	12225403	25
SW-104	31600238	117
SW-108	31600239	117
SW-116	31600240	117
SW-124	31600241	117
T-500	11205500P	109

Reference	Code	Page
T-510R	11205510P	109
T-520/G2+	12210120	108
T-520 LITE/G2+	12210121	108
TAGDOOR-4K-EV	20710010	134
TAGDOOR MF+	20780208	134
TAGDOOR MF+ BLUE	20710011	134
TAGDOOR MF+ GREEN	20710013	134
TAGDOOR MF+ ORANGE	20710014	134
TAGDOOR MF+ RED	20710012	134
TAGDOOR MF+ WHITE	20710020	134
TAGDOOR MF+ YELLOW	20710015	134
TAGKEY ID	20710007	62
TAGKEY ID	20710007	73
TAGKEY ID	20710007	79
TAGKEY ID	20710007	135
TAGNFC/US	11812125	17
TAGNFC/US	11812125	55
TAGNFC/US	11812125	62
TAGNFC/US	11812125	73
TAGNFC/US	11812125	79
TAGNFC/US	11812125	135
TAGSET/5	12240450	21
TAGSET/PROG	12240452	21
T-ART/G2+	12210100	107
T-ART LITE/G2+	12210101	107
TF-104	20691040	117
TF-104	20691040	135
TLB-N	20700005	138
TLB-N-SS	20700028	138
TLB-SQ	20700006	138
TLB-SQ-SS	20700027	138
TR0	20760308	133
UC	11259990	63
UC	11259990	81
UC-6502	12396510	73
UC-6502/LARGE	12396511	73
UC-CE640/SUPRA	12590100	63
UTP-CAT6	31600300	119
VIS-295/GRF	11290499A	29
VIS-295/GRF	11290499A	43
VIS-GM-KR-IPOP	20700135	127
WCONTROL	20730010	128

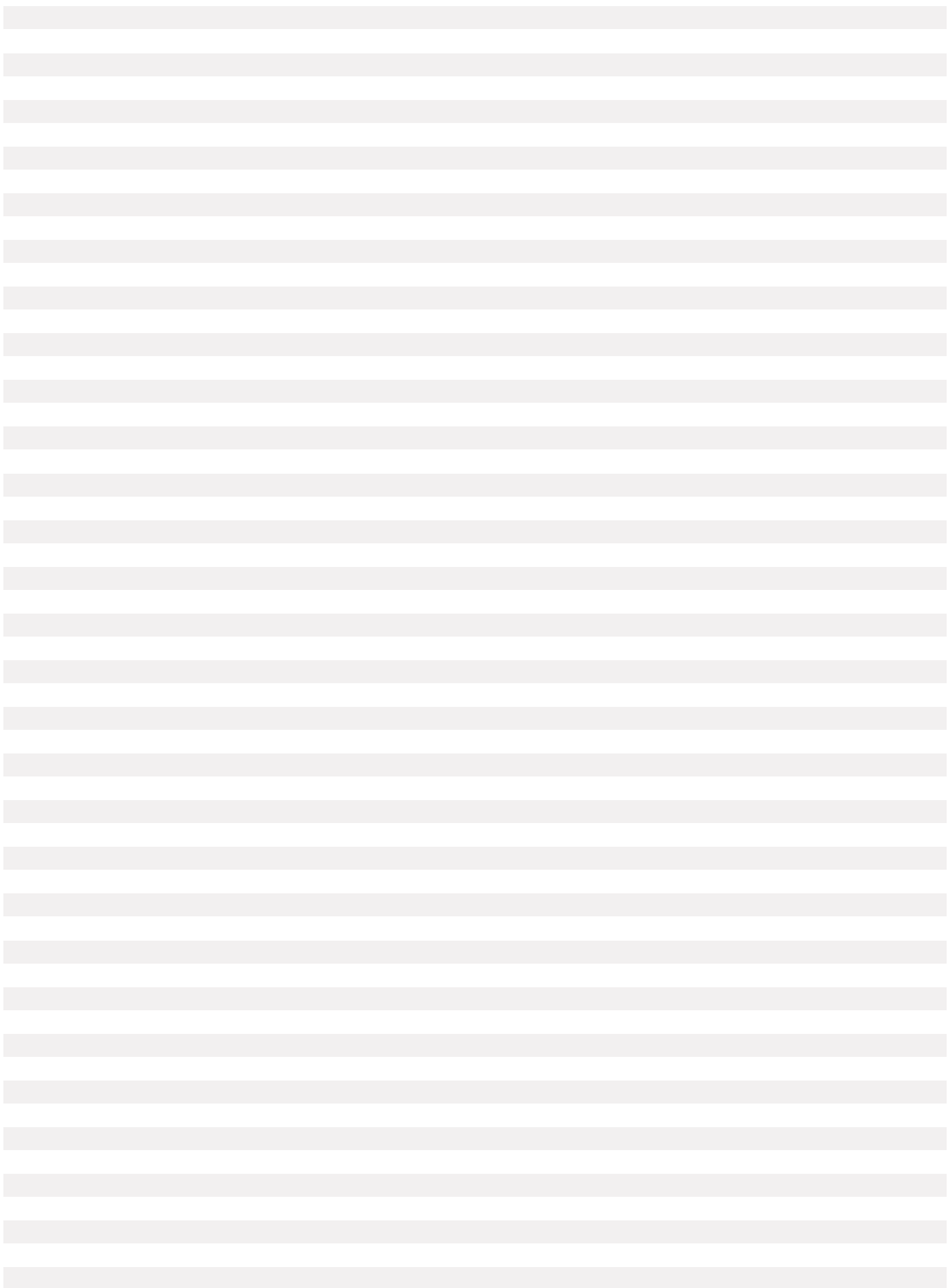

GENERAL CONDITIONS OF SALE

These general conditions of sale (*) apply strictly to all sales of products made by GOLMAR Sistemas de Comunicación, SA (hereinafter GOLMAR), except for any other specific written agreement with the customer.

PRICES, PAYMENTS

Prices are listed in the current official price list and are per unit and in euros. They are for sale to the public and do not include VAT, shipping, or other taxes, fees, or charges.

Payments shall be made to GOLMAR within the agreed terms and for the amounts agreed. Failure or delay in payment of any sum owed to GOLMAR may result in the application of the provisions of Law 3/2004, of December 29, to the suspension of the execution of other pending orders and, after 60 days have elapsed without any amount owed being paid, to the termination of any existing contractual relationship between the parties.

DELIVERIES AND AVAILABILITY

Product availability is immediate from the central warehouse, except in exceptional circumstances, under pre-order conditions, or with a delivery time "to be consulted". Delivery times are always approximate, and penalties for late delivery are not applicable.

SHIPPING

Freight charges for non-urgent shipments to the Peninsula and Balearic Islands will be paid for full delivery notes with a minimum amount of 600€.

For shipments to the Canary Islands, the minimum amount is 1,200€.

In both cases, they will be handled by a transport agency chosen by GOLMAR.

In cases where the merchandise travels at the customer's expense and risk, shipping, insurance, and other costs inherent to the shipment of the goods are the customer's responsibility.

RETURNS

All product returns must always be authorized in advance by GOLMAR. Returns due to causes beyond GOLMAR's control will be subject to a 15% depreciation of their purchase value.

Before returning products, it is essential to submit a "Return Request" to GOLMAR, stating the reasons for the return and the details of the associated invoice.

"Return Requests" are not accepted after 30 calendar days from the date of purchase.

Once this request has been accepted in writing, the customer may return the products. These products must be in perfect condition and available for sale with their original boxes and intact packaging, with shipping costs to be paid by the customer.

Returns of used, discontinued, special, custom-made, or non-original products will not be accepted. Special products are defined as those not included in the current rates.

CLAIMS

The customer agrees to review the quantity, correspondence, and integrity of the products received in each shipment within a maximum of five days from the delivery date. After this period, no claims will be accepted for the aforementioned reasons.

RESERVATIONS

A retention of title is established for products purchased by a customer in favor of GOLMAR until full payment has been made. The risks inherent in the products supplied will be transferred to the customer upon delivery by GOLMAR.

Any payment by check and/or promissory note is for payment purposes only. Ownership of the products will transfer to the customer upon full settlement of the debt.

The delivery of a check and/or the simultaneous establishment of a financial relationship is not considered redeemable. Payments will always be considered to cover outstanding invoices.

SAMPLES

GOLMAR does not provide products as samples or for testing. Any delivery of products will be considered a sale, meriting a commitment to pay under the conditions agreed upon delivery, and in accordance with current legislation.

JURISDICTION

In the event of a dispute between the parties regarding the fulfilment and execution of these conditions, the Courts and Tribunals of Barcelona shall have sole jurisdiction, with Spanish law applying. The parties expressly waive their own jurisdiction and rights if they differ from the above.

(*) GOLMAR reserves the right to modify these general conditions of sale, as well as the prices and technical and aesthetic characteristics of the products without prior notice.

WARRANTY

GOLMAR will respond to the lack of conformity of its products from the date of its sales invoice for a period of 3 years, if it is verified that it is a consequence of a defective component or manufacturing fault, provided that it is notified without delay after its appearance and complying with the terms set out in current legislation.

Products processed as warranties that do not comply with the provisions of this section and GOLMAR's general sales conditions will be considered out of warranty.

The warranty consists of the repair or replacement of the elements that have been found to be defective, either due to material or manufacturing defects. GOLMAR will respond to all warranty claims from its customers and in the cases provided for in Article 125 of Royal Decree-Law 1/2007.

The warranty does not cover deficiencies, damages or breakdowns caused to the products by: improper or negligent use, impacts, vandalism, repairs or manipulations not carried out by GOLMAR or by Technical Services authorized by GOLMAR, causes beyond the design or manufacture of the product (for example, power supply failures), incorrect installation or start-up of the equipment or carried out in places not suitable for the correct operation of the equipment, failure to follow the instructions in the product manuals, adverse environmental conditions, chemical or electrochemical effects or by contact with inappropriate substances, scratches or scrapes that do not affect normal operation, inadequate or non-performed maintenance of the equipment or installations, damage during transport or during unpacking not attributable to the manufacturer, use of the product with accessories or other products of a type, condition or standards not specified by GOLMAR, or absence or illegibility of the serial number label.

The liability of GOLMAR and its employees, subcontractors and suppliers for claims arising from the performance or non-performance of their contractual obligations shall not exceed the basic contractual price in the aggregate and shall not in any event include damages arising from loss of profits, revenue, production or use, capital costs, downtime costs, delays and claims of the Buyer's customers, loss of anticipated savings, or any other special, indirect or consequential damages.

Digital services and continuity of service: For all digital services associated with a product supplied by GOLMAR, the warranty and service continuity period for its customers is 3 years from the date of the sales invoice. GOLMAR will provide at least 6 months' notice in the event of closure or interruption of service, maintaining the warranty described above. Substantial changes to the contractual terms of service will be notified at least 3 months in advance.

Note:

Components and products replaced during the warranty period will remain the property of GOLMAR.

GOLMAR is not responsible for the data or information in any electronic format stored in the products or components, nor for their preservation, integrity, or restoration, during the time or process of repair or replacement of products and/or components.

The validity of the warranty is subject to the existence and correspondence of the purchase invoice.



golmar.es

Golmar Sistemas de Comunicación S.A.

C/ Silici, 13

08940 Cornellà de Llobregat, Barcelona (Spain)

(+34) 934 800 696

golmar@golmar.es